



POWERTRAIN
CHASSIS
BODY
WORKSHOP
TORQUE
PULLERS
HYDRAULICS

Product Range

POWERTRAIN



Powertrain - includes an extensive range of premium servicing and repair tools combined with Sykes-Pickavant's renowned diagnostic gauge tools for compression, pressure and vacuum testing

CHASSIS



Chassis - comprehensive range of unique and innovative tools built strong to tackle the demands of repairing brakes, steering and suspension, wheel and tyre automotive systems

BODY



Body - tools for panel preparation and body work repair including panel beating hammers, dollies, spoons, body blades and holders, sheet metal tools and hole cutters. Manufactured from premium materials for the superior craftsman

WORKSHOP



Workshop - stud setters and splitters, multimeters, circuit testers, thread repair and screw extraction. Features a diverse range of quality diagnostic, inspection, stud and nut tools

TORQUE



Torque - equipment high quality precision torque instruments such as torque wrenches, multipliers and angle gauges

PULLERS



Pullers - world famous for their superior quality, interchangeable components and extensive spare parts program. Includes mechanical, hydraulic, Loadstar and special purpose pullers

HYDRAULICS



Hydraulics - premium range of hydraulic pumps, cylinders and jacking kit options

Contents

POWERTRAIN Page		BODY cont. Page		PULLERS cont. Page	
Engine & Transmission		Edge Setter		Mechanical Thin Jaw Gear	
Petrol Compression Testing	6	Flanging and Crimping	79	Twin Leg	115
Diesel Compression Testing	7	Self Grip Pliers		Triple Leg	115
Cylinder Leakage Testing	13	Welding Clamps	80	Mechanical Thin Jaw Puller Kits	116
Oil Pressure Testing	15	Grip Wrenches	82	Hydraulic Gear	
Cylinder Honing	16	General Body Tools		Ram	118
Piston Ring Compressing	17	Radio Removal	83	Twin Leg	119
Valve Repair	17	Body Trim	83	Triple Leg	119
Oil Filter Removal	21	Door Hinge	84	Hydraulic Puller Kits	120
Engine Timing	22			Hydraulic Thin Jaw Gear	
Transmission	23	WORKSHOP Page		Twin Leg	131
Cooling		Electrical Testing		Triple Leg	131
Cooling System Testing	24	Circuit Testing	86	Hydraulic Thin Jaw Puller Kits	132
Coolant/Anti-Freeze Fluid Testing	29	Battery	87	Loadstar Heavy Duty	
Fuel & Exhaust		Multimeters & Amp Clamps	88	Loadstar 8, 12, 20 Tonne Kits	134
Fuel Pressure Testing	30	Inspection		Loadstar Plus 20 Tonne Kits	136
Vacuum Testing	36	RPM/Tachometer	91	Loadstar Plus 30 Tonne Kits	140
Diesel Fuel Injector Tools	37	Temperature/Thermometer	91	Loadstar Plus 50 Tonne Kits	142
Exhaust Gas Testing	40	Sonoscope	92	Slide Hammer Pullers	
		Electronic ChassisEar	92	Combi Pull Internal/External	144
CHASSIS Page		Stud and Nut		Split Collet Extractors	146
Brakes		Thread Restoring	93	Pullers and Bearing Separators	
Brake Pipe Tools	42	Extractors / Setters	93	External Bearing	148
Brake Fluid Tools	47	Nut Splitters	94	Bearing Separators	149
Brake Pad and Disc Tools	49	General		Blind Housing Bearing	150
Steering & Suspension		Workshop Tools	95	Hub and Stud Pullers	
Spring Compressors & Strut	52	TORQUE Page		Adjustable - Car, LCV	151
Ball Joint Separators	57	Wrenches		Adjustable - CV	151
Hub Pullers & Bearing Tools	59	Motorq - Professional	98	Fixed Plate - Car, LCV	152
Diagnostic	65	Motorq - Heavy Duty	100	Truck and HGV	153
Wheel & Tyre		Angle Gauges		Puller Boards	155
Tyre Pressure Testing	66	Analog, Digital	101	Kit Contents Listing	162
Tread Depth Measuring	66	Multipliers		Component and Kit Illustrations	167
		< 3000Nm, > 3000Nm	102	HYDRAULICS Page	
BODY Page		Maintenance		Safety Information	181
Body Repair Tools		TruCheck Plus™	103	Pumps	
Preparation and Maintenance	68	Screwdrivers		Steel, Aluminium	182
Hammers	70	< 3.0Nm, > 3.0Nm	104	Cylinders	
Mallets	71	PULLERS Page		20T, 30T, 50T	183
Dollies	72	Reference Guide	106	Jacking and Press Kits	
Bumping Spoons and Tools	73	Mechanical Gear		20T, 30T, 50T	184
Tool Sets	74	Twin Leg	108	Accessories	
Panel Pulling	76	Triple Leg	109	Hoses, Couplers, Gauges	186
Body Blades	76	Twin/Triple Leg	109	NUMERICAL INDEX	187
Hole Cutting Tools		Mini Twin/Triple Leg	110	ALPHABETICAL INDEX	190
Hole Cutters	77	Mechanical Puller Kits	111		
Sheet Metal Tools					
Cutting and Folding	78				

History

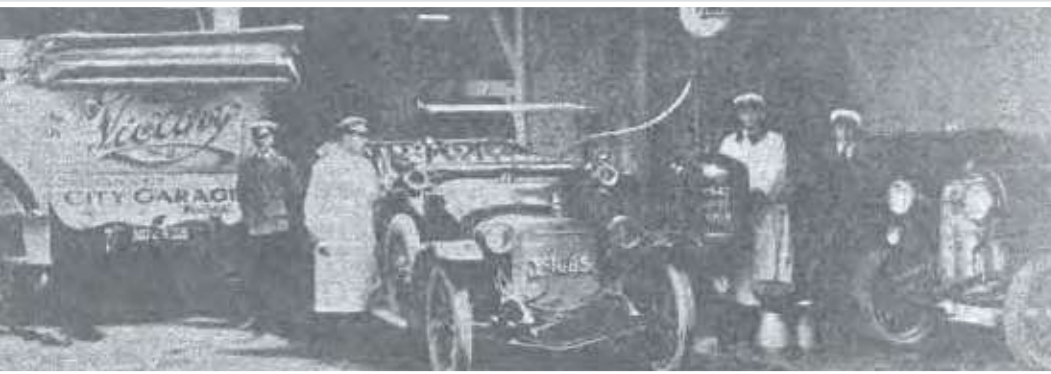

How it Began

It was 1921 - the start of the garage trade in England and the beginning of the Sykes-Pickavant story.

Jack Pickavant saw the opportunities presented by the burgeoning garage trade and formed J.W. Pickavant & Co Ltd to market motor accessories, spares and tools. Joe Sykes also joined the company as its first salesman to call on garages and engineering shops.

By the end of the twenties 'Pickavant' moved firmly into the field of manufacture of service tools as mechanics faced the problem of repair and service on more sophisticated cars and trucks. This presented an opportunity for 'Pickavant' to create new tools to do these jobs speedily and efficiently.

The Early Years

In 1931 Joe Sykes left J.W. Pickavant & Co Ltd to launch out on his own as a tool distributor under the brand 'Sykes'. After the war, import rationing was a dominant factor such that J.F. Sykes also took the first steps into manufacturing and assembly.

By 1950 Joe Sykes set his sights on export and his first overseas markets were Australia, New Zealand and South Africa.

A mutual respect and trust was very much alive between both companies and they operated side by side in a spirit of friendly rivalry.



The Merger

In 1968 a merger was formed and Sykes-Pickavant Ltd began operating on 1 January 1969.

In the 1970s they built a large new factory and office block in Lytham, St Annes. This allowed full quality control of all manufacturing and distribution.

By the 1980s forty percent of the company's business was export.

Sykes-Pickavant continued to grow and expand into Europe and Asia with attendance at all major tool shows to launch world class products such as the 1500 series puller system and unique garage service tools. Participation in these exhibitions and trade shows played an important part in overall marketing policy.

Today

The need to keep up with changes in vehicle and equipment design ensures that Sykes-Pickavant products are constantly updated to do the work for which they were intended.

With over 450 part numbers now in the range, Sykes-Pickavant continues to offer the highest quality products with many applications in the field of automotive and general engineering maintenance and repair work.

The history of Sykes-Pickavant established the reputation of today - to supply high quality, practical and time saving products to industry and the motor trade. Sykes-Pickavant continues to provide solutions with unique and innovative products.





 Sykes-Pickavant®

POWERTRAIN

PETROL COMPRESSION TESTING

Petrol Compression Tester 

- Checks cylinder compression to assist in the diagnosis of faulty valves, piston rings, cylinder heads and gaskets
- Features a shock protected, easy to read dual scale gauge for quick and accurate checks
- Pressure relief valve allows repeated cylinder tests without removing the gauge
- Available with 300mm or 460mm rubber hose with dual threads (M14 & M18)



Part No.	Description	Length (mm)	Gauge Dia. (mm)	Gauge Scale	Thread
314000	Petrol Compression Tester	305	83	0-20 bar / 0-300 psi	M14 & M18
314020	Petrol Compression Tester – Long	460	83	0-20 bar / 0-300 psi	M14 & M18
314005	Gauge Service Kit				

314003

Petrol Compression Tester Kit 

- Comprehensive kit based on **314000** Petrol Compression Tester
- The gauge features a dual scale (0-20 bar / 0-300 psi)
- Suitable for vehicles with M10, M12, M14 and M18 spark plug threads
- Includes thread chasers to prevent cross-threading resulting from dirty or damaged threads
- Optional extra long flexible adaptors available



Contents

Part No.	Description	Thread	Length (mm)
314000	Gauge Assembly	M14, M18	305
314002	M14 Extension – Short	M14 x 1.25	63
314004	M14 Extension – Long	M14 x 1.25	94
314007	M18 Extension	M18 x 1.50	57
314010	M10 Extension	M10 x 1.00	57
314012	M12 Extension	M12 x 1.25	57
660612	Thread Chaser	M10, M12	–
014100	Thread Chaser	M14, M18	–
314005	Gauge Service Kit	–	–

Flexible Adaptors

- Two extra long adaptors designed to complement and extend the application capacity of Petrol Compression Testers **314000**, **314020** and **314003**

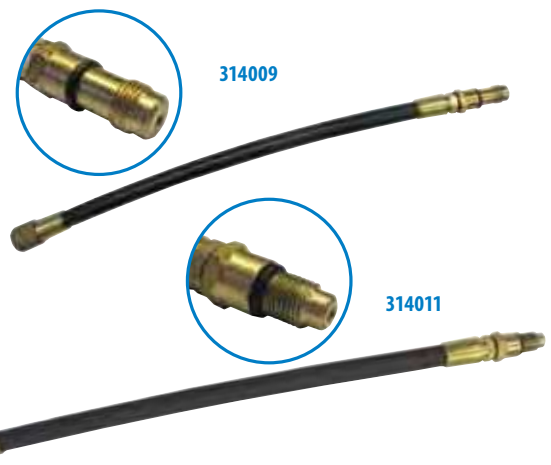

Part No.	Description	Thread	Length (mm)
314009	Extra Long Flexible Adaptor	M14	158
314011	Extra Long Flexible Adaptor	M12	380

ENGINE & TRANSMISSION

314050

Petrol Compression Test Kit – Quick Release

- Specially designed for deep seated spark plug ports with long narrow threads found on many modern petrol engines
- Specially designed self centring adaptors ensure minimal risk of cross threading when attempting to screw the compression adaptor in to the spark plug port, a must feature for deep seated spark plug ports
- Positive lock quick release connector ensures adaptors can't accidentally be left in the spark plug port
- Gauge features a dual scale (0-20 bar / 0-300 psi), adheres to DIN16005, DIN16063 and BS1780 standards
- Supplied with 500mm braided, flexible rubber hose



Contents

Part No.	Description	Thread
31405070	Gauge Assembly	
314051	QR – Spark Plug Adaptor	M10 Universal
314052	QR – Spark Plug Adaptor	M12 Universal
314053	QR – Spark Plug Adaptor	M14 Universal
314054	QR – Spark Plug Adaptor	M14 Ford Duratec



DIESEL COMPRESSION TESTING

314275

Diesel Compression Test Kit – Common Rail Diesel (CRD)

- Comprehensive compression test kit specifically designed to cover a wide range of modern CRD injected engines
- Checks engine compression under cranking conditions
- Enables cylinder access through dummy injector and glow plug adaptors
- Includes large, shock protected gauge featuring dual scale (0-60 bar / 0-860 psi) DIN16005, DIN16063, BS1780 standards
- Pressure relief valve allows repeated cylinder tests without removing the gauge
- Includes CRD dummy injector and clamps for applications where it is easier to remove the injector
- Supplied with vehicle application list in blow moulded case
- Spare Parts:
 - 314005** Service Kit for Compression Gauge
 - 014215** Seal and Washer Kit



Contents

Part No.	Description	Thread	Length (mm)
314201	Gauge Assembly	–	560
314219	Extension Rod	–	190
314278	Injector End	–	–
314287	Hdi Injector Clamp Piezo	–	–
31428870	Injector Clamp	–	–
314336	Lock Nut	–	–
314277	Dummy Glow Plug	M8 x 1.0	108
314231	Dummy Glow Plug	M8 x 1.0	114
314223	Dummy Glow Plug	M8 x 1.0	115
314216	Dummy Glow Plug	M9 x 1.0	135
314254	Dummy Glow Plug	M10 x 1.0	83

Part No.	Description	Thread	Length (mm)
314259	Dummy Glow Plug	M10 x 1.0	83
314252	Dummy Glow Plug	M10 x 1.0	93
314274	Dummy Glow Plug	M10 x 1.0	102
314249	Dummy Glow Plug	M10 x 1.0	113
314268	Dummy Glow Plug	M10 x 1.0	113
314217	Dummy Glow Plug	M10 x 1.0	160
314267	Dummy Glow Plug	M10 x 1.0	162
314209	Dummy Glow Plug	M10 x 1.25	130
314269	Dummy Glow Plug	M10 x 1.25	134
314271	Dummy Glow Plug	M10 x 1.25	145

DIESEL COMPRESSION TESTING cont.

314200

Diesel Compression Test Kit – Standard Car 

- Comprehensive compression test kit suitable for both direct and indirect injected engines
- Checks engine compression under cranking conditions
- Enables cylinder access through dummy injector and glow plug adaptors
- Includes large, shock protected gauge featuring dual scale (0-60 bar / 0-860 psi) DIN16005, DIN16063, BS1780 standards
- Pressure relief valve allows repeated cylinder tests without removing the gauge
- Supplied with vehicle application list in blow moulded case
- Spare Parts:
 - 314005** Service Kit for Compression Gauge
 - 014215** Seal and Washer Kit



Contents

Part No.	Description	Thread	Length (mm)
314201	Gauge Assembly	–	560
314730	90° Elbow Connector	–	–
314215	Dummy Glow Plug	M8 x 1.0	102
314220	Dummy Glow Plug	M10 x 1.0	63
314254	Dummy Glow Plug	M10 x 1.0	83
314259	Dummy Glow Plug	M10 x 1.0	83
314252	Dummy Glow Plug	M10 x 1.0	93
314274	Dummy Glow Plug	M10 x 1.0	102
314249	Dummy Glow Plug	M10 x 1.0	113
314210	Dummy Glow Plug	M10 x 1.25	73
314240	Dummy Glow Plug	M12 x 1.25	47
314235	Dummy Injector	M20 x 1.5	75
314225	Dummy Injector	M24 x 2.0	64

314295

Diesel Compression Test Kit – Premier Car 

- Comprehensive diesel compression test kit for both direct and indirect diesel injected engines
- Features additional applications compared with standard car kit for Mercedes, VW / Audi, Land Rover and PSA
- Includes large, shock protected gauge featuring dual scale (0-60 bar / 0-860 psi) DIN16005, DIN16063, BS1780 standards
- Pressure relief valve allows repeated cylinder tests without removing the gauge
- Supplied with vehicle application list in blow moulded case
- Spare Parts:
 - 314005** Service Kit for Compression Gauge
 - 014215** Seal and Washer Kit

**Contents**

Part No.	Description	Thread	Length (mm)
314201	Gauge Assembly	–	560
314730	90° Elbow Connector	–	–
314888	Poly Hose - Green	–	–
314246	Dummy Injector Spacer	–	–
314227	Dummy Glow Plug No 2	Mazda	–
314215	Dummy Glow Plug	M8 x 1.0	102
314216	Dummy Glow Plug	M9 x 1.0	135
314220	Dummy Glow Plug	M10 x 1.0	63
314254	Dummy Glow Plug	M10 x 1.0	83
314259	Dummy Glow Plug	M10 x 1.0	83
314252	Dummy Glow Plug	M10 x 1.0	93
314274	Dummy Glow Plug	M10 x 1.0	102
314249	Dummy Glow Plug	M10 x 1.0	113
314268	Dummy Glow Plug	M10 x 1.0	113
314234	Dummy Glow Plug	M10 x 1.0	119
314267	Dummy Glow Plug	M10 x 1.0	162
314241	Dummy Glow Plug	M10 x 1.25	64
314210	Dummy Glow Plug	M10 x 1.25	73
314269	Dummy Glow Plug	M10 x 1.25	134
314271	Dummy Glow Plug	M10 x 1.25	145
314240	Dummy Glow Plug	M12 x 1.25	47
314235	Dummy Injector	M20 x 1.5	75
314245	Dummy Injector	M22 x 1.5	118
314236	Dummy Injector	M22 x 1.5	73
314239	Dummy Injector	M24 x 1.5	73
314225	Dummy Injector	M24 x 2.0	64



ENGINE & TRANSMISSION

DIESEL COMPRESSION TESTING cont.

Diesel Compression Tester Adaptors

- Range of glow plug adaptor sets designed to complement and extend the application capacity of Sykes-Pickavant diesel compression testers
- Each set contains the appropriate glow plug adaptors for a particular engine series, which often cover more than one manufacturer
- Applications for the full range of adaptor sets are provided with each set
- Optional dummy glow plug extension rod available to suit all kits
314219 Glow Plug Adaptor Extension 190mm

314288

Applications:

- Mercedes CDI 2.0, 2.1, 2.2, 2.7, 3.0, 3.2, 3.9, 4.0 (M8 & M10)
- Opel / GM 1.7Di, DTI, CDTI, 2.0 / 2.2DT, DTI, DDTI
- Also fits VAG Common Rail 1.6, 2.0, 2.7, 3.0TDI



Contents

Part No.	Description
314223	Dummy Glow Plug / M8 x 1.00 x 115
314268	Dummy Glow Plug / M10 x 1.00 x 113
314269	Dummy Glow Plug / M10 x 1.25 x 134

314289

Applications:

- IND-TV 1.4D Fitted to Auris, IQ, Corolla, Urban Cruiser, Yaris
- Mini One W17D141.4D, 1CD-FTV 2.0D-4D, AD-FTV 2.0D-4D, 2AD-FH / TV 2.2D-4D
- S2/200D Fitted to Toyota and Lexus



Contents

Part No.	Description
314209	Dummy Glow Plug / M10 x 1.25 x 130
314271	Dummy Glow Plug / M10 x 1.25 x 145

314291

Applications:

- Citroen 1.4, 1.6, 2.0, 2.2, 2.7HDI
- Fiat Scudo Ulysse 2.0JTD, 2.2JTD, 2.2JTDM
- Ford 1.4, 1.6, 2.0, 2.2TDCI
- Jaguar / Land Rover 2.2, 2.7TD
- Peugeot 1.4, 1.6, 2.0, 2.2, 2.7HDI
- Volvo 1.6, 2.0, 2.4D



Contents

Part No.	Description
314231	Dummy Glow Plug / M8 x 1.00 x 114
314252	Dummy Glow Plug / M10 x 1.00 x 93
314277	Dummy Glow Plug / M8 x 1.00 x 108
31428570	Dummy Glow Plug / M8 x 1.00 x 76

314292

Applications:

- Alfa Romeo 1.3JTDM 16V, 1.6JTDM 16V, 1.9JTD 8V, 1.9 JTDM 8V, 1.9JTD/M 16V, 2.0JTDM, 2.4JTD 10V, 2.4JTD/M 20V
- Fiat 1.3MJTD 16V, 1.6JTD, 1.9 JTD/M/DM, 2.0JTDM, 2.3DJTDM, 2.4JTDM, 3.0JTD
- Saab 1.9D, T1D1.9D, TTID
- Vauxhall 1.3DTI, 1.3CDTI, 1.9CDTI, 2.0D CDTI



Contents

Part No.	Description
314216	Dummy Glow Plug / M9 x 1.00 x 135
314218	Dummy Glow Plug / M8 x 1.00 x 127
314231	Dummy Glow Plug / M8 x 1.00 x 114
314259	Dummy Glow Plug / M10 x 1.00 x 83

314293

Applications:

- K9K 1.5DCI, F9Q 1.9DCI, D4192T 1.9D Fitted on Dacia, Nissan, Suzuki, Volvo
- M9R 2.0DCI, M9T 2.3CDTI Fitted on Nissan, Opel / GM, Renault
- G9T 2.2DCI, Y22DDT 2.2DCI, G9U 2.5DCI, Y25DDTI 2.5DCI Fitted on Nissan, Opel / GM, Renault



Contents

Part No.	Description
314217	Dummy Glow Plug / M10 x 1.00 x 160
314267	Dummy Glow Plug / M10 x 1.00 x 162
314274	Dummy Glow Plug / M10 x 1.00 x 102

314294

Applications:

- Glow plug: Ford 1.8DT, TDCI, TDDI, 2.0 16V TDCI, 2.0, 2.2, 2.4, 3.2 DDDI
- Dummy Injector: Ford 2.0, 2.2, 2.4 Duratorq Diesel Injector



Contents

Part No.	Description
314249	Dummy Glow Plug / M10 x 1.00 x 113
314254	Dummy Glow Plug / M10 x 1.00 x 83
314281	Dummy Injector / M22 x 1.50 x 154

314285

Diesel Compression Test Kit – Land Rover 

- Diesel compression test kit developed for popular Land Rover models such as Discovery, Freelander, Range Rover, Defender and Evoque
- Checks engine compression under cranking conditions
- Includes large, shock protected gauge featuring dual scale (0-60 bar / 0-860 psi) DIN16005, DIN16063, BS1780 standards
- Pressure relief valve allows repeated cylinder tests without removing the gauge
- Spare Parts:
314005 Service Kit for Compression Gauge



Contents

Part No.	Description	Thread	Length (mm)
314201	Gauge Assembly	–	560
31428570	Dummy Glow Plug	M8 x 1.0	76
314277	Dummy Glow Plug	M8 x 1.0	108
314274	Dummy Glow Plug	M10 x 1.0	102
314249	Dummy Glow Plug	M10 x 1.0	113

314280

Diesel Compression Test Kit – LCV 

- Specialist compression test kit designed to cover a wide range of direct and indirect diesel injected engines
- Specifically suited to light commercial vehicles
- Checks engine compression under cranking conditions
- Enables cylinder access through dummy injector and glow plug adaptors
- Includes large, shock protected gauge featuring dual scale (0-60 bar / 0-860 psi) DIN16005, DIN16063, BS1780 standards
- Pressure relief valve allows repeated cylinder tests without removing the gauge
- Supplied with vehicle application list in blow moulded case
- Spare Parts:
314005 Service Kit for Compression Gauge
014215 Seal and Washer Kit

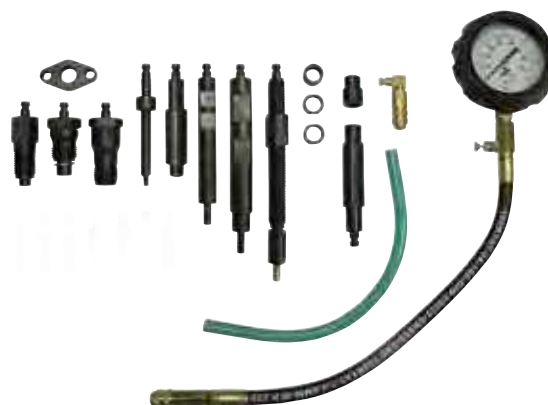

Contents

Part No.	Description	Thread	Length (mm)
314201	Gauge Assembly	–	560
314730	90° Elbow Connector	–	–
314314	Centre Pillar	–	130
314316	Pilot Pin	–	7
314320	End Adaptor No 2	–	–
314326	Spacer No 2	–	–
314336	Lock Nut	–	–
314348	Iveco Injector End	–	–
314287	Hdi Injector Clamp Piezo	–	–
314888	Poly Hose - Green	–	355
314274	Dummy Glow Plug	M10 x 1.0	102
314249	Dummy Glow Plug	M10 x 1.0	113
314268	Dummy Glow Plug	M10 x 1.0	113
314267	Dummy Glow Plug	M10 x 1.0	162
314254	Dummy Glow Plug	M10 x 1.0	83
314252	Dummy Glow Plug	M10 x 1.0	93
314241	Dummy Glow Plug	M10 x 1.25	64
314210	Dummy Glow Plug	M10 x 1.25	73

Part No.	Description	Thread	Length (mm)
314240	Dummy Glow Plug	M12 x 1.25	47
314221	Dummy Injector	Direct Injection	114
314242	Dummy Injector	Land Rover	152
314244	Dummy Injector	Land Rover	104
314230	Dummy Injector	Stanadyne	112
314238	Dummy Injector	VAG	–
314235	Dummy Injector	M20 x 1.5	75
314236	Dummy Injector	M22 x 1.5	73
314225	Dummy Injector	M24 x 2.0	64

DIESEL COMPRESSION TESTING cont.

314300

Diesel Compression Test Kit – HGV 

- Specialist compression test kit designed to cover a wide range of direct and indirect diesel injected engines
- Specifically suited to heavy duty diesel engines such as in industrial, plant, marine and agriculture equipment
- Checks engine compression under cranking conditions
- Includes large, shock protected gauge featuring dual scale (0-60 bar / 0-860 psi) DIN16005, DIN16063, BS1780 standards
- Pressure relief valve allows repeated cylinder tests without removing the gauge
- Supplied in blow moulded case
- Spare Parts:
 - 314005** Service Kit for Compression Gauge
 - 014215** Seal and Washer Kit

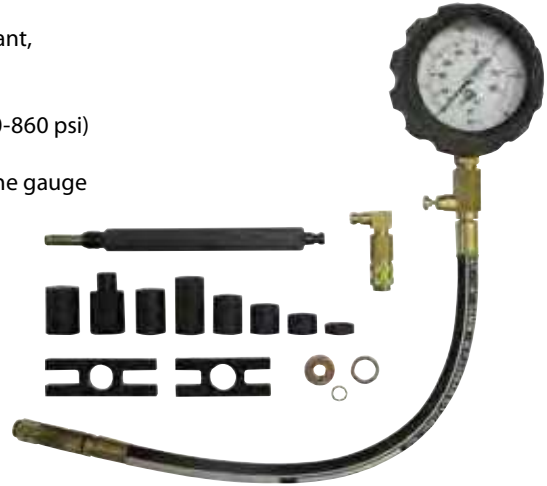

Contents

Part No.	Description	Scale / Measurement	Length (mm)
314201	Gauge Assembly	0-60 bar / 0-860 psi	560
314730	90° Elbow Connector	–	–
314260	Spacer Set	–	–
014222	Clamp Plate	25mm Width 17mm Hole Dia.	63.5
014255	Clamp Plate	15mm Width 17mm Hole Dia.	76.2
314251	Centre Pillar	5/16" x 24 UNF Int. 1/2" x 20 UNF Ext.	185
314256	End Adaptor	20.5mm Ext. Dia.	30
314257	End Adaptor	23.6mm Ext. Dia.	32
314258	End Adaptor	23.6mm Ext. Dia.	41



CYLINDER LEAKAGE TESTING

313800

Cylinder Leakage Tester – Petrol & Diesel

- An alternative to conventional compression testers which provides a direct indication to the location of the leak by measuring the rate of loss of compression for individual cylinders
- Helps to diagnose worn and broken piston rings, burnt and leaking valves and faulty head gaskets
- Supplied with a wide variety of adaptors to fit the majority of petrol and diesel engines on cars, LCV's, motorcycles, marine engines etc.
- Spare Parts:
014215 Seal and Washer Kit

Specifications - Gauge

Height	Width	Depth	Gauge Dia.	Air Pressure	Hose
100mm	200mm	175mm (inc. Adaptors)	70mm	Min 5bar - Max 8bar	2m

Contents

Part No.	Description	Thread	Length (mm)
313801	Cylinder Leakage Tester Assembly	–	–
014222	Clamp Plate	25mm Width 17mm Hole Dia.	63.5
313802	Hose Assembly	–	200
313803	Whistle Assembly	–	–
313811	Male Quick Connect Adaptor	M18	–
314274	Dummy Glow Plug	M10 x 1.0	102
314234	Dummy Glow Plug	M10 x 1.0	119
314210	Dummy Glow Plug	M10 x 1.25	73
314233	Dummy Glow Plug	M10 x 1.25	114
314240	Dummy Glow Plug	M12 x 1.25	47
314221	Dummy Injector	Direct Injection	–
314230	Dummy Injector	Stanadyne	–
314235	Dummy Injector	M20 x 1.5	75
314225	Dummy Injector	M24 x 2.0	64
314010	Spark Plug Adaptor / Extension	M10 x 1.0	57
314012	Spark Plug Adaptor / Extension	M12 x 1.2	57
314002	Spark Plug Adaptor / Extension	M14 x 1.25	63
314004	Spark Plug Adaptor / Extension	M14 x 1.25	94
314007	Spark Plug Adaptor / Extension	M18 x 1.5	57

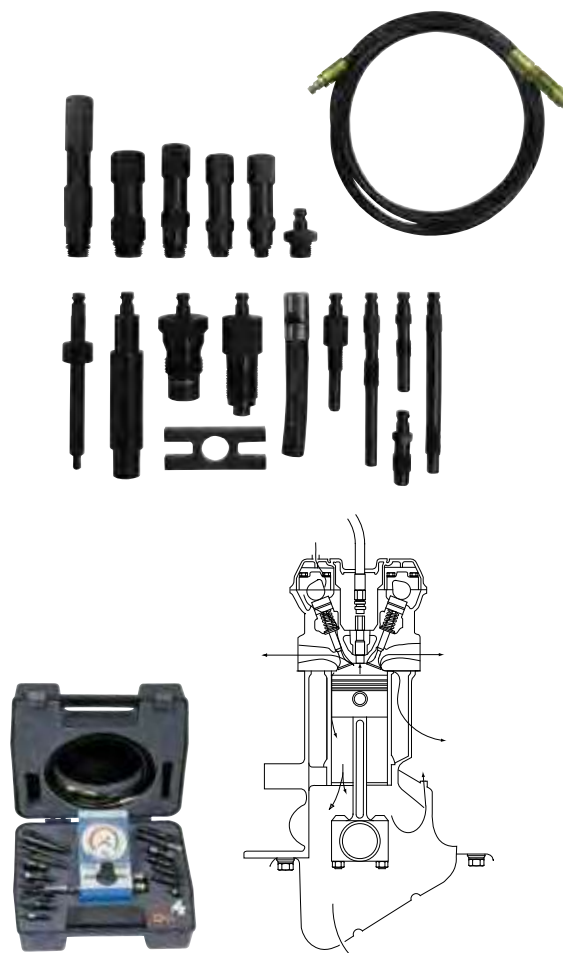

313805

Cylinder Leakage Tester – Unit & Hose

- As per **313800** excluding adaptors
- Made available to customers owning a comprehensive Sykes-Pickavant compression tester already fitted with required adaptors
- Includes cylinder leakage tester assembly and 2 metre hose
- Supplied in blow moulded case with foam insert



ENGINE & TRANSMISSION

Diesel Compression Kit Contents Comparison Table - Reference by Part Number

Ref.	Length (mm)	Thread	Make	Engine	Kit Contents									
					314200	314275	314285	314295	314288	314289	314291	314292	314293	314294
Dummy Glow Plugs														
314209	130	M10 x 1.25	Mini / Toyota	1.4D		●				●				
314210	73	M10 x 1.25	Old Ford / Vag	1.9PD	●			●						
314215	102	M8 x 1.0	Ford / PSA	1.4 / 1.6HDI	●			●						
314216	135	M9 x 1.0	Alfa / Fiat / GM	1.6 / 1.9 / 2.0D		●		●				●		
314217	160	M10 x 1.0	Renault / Nissan	M9R		●							●	
314218	127	M8 x 1.0	Fiat / Iveco	2.3 / 3.0 JTD								●		
314220	63	M10 x 1.0	PSA / Renault	1.9D / DW8	●		●	●						
314223	115	M8 x 1.0	Mercedes	New CDI		●			●					
314231	114	M8 x 1.0	Flat / GM	1.3JTD		●				●	●			
314233	114	M10 x 1.25	Nissan	2.0D				●						
314234	119	M10 x 1.0	Land Rover	200 / 300TDI				●						
314240	47	M12 x 1.25	Common	Old apps	●			●						
314241	64	M10 x 1.25	Mitsubishi	Old apps				●						
314249	113	M10 x 1.0	Ford	2.0TDCI	●	●	●	●						●
314252	93	M10 x 1.0	PSA	2.0HDI	●	●		●		●				
314254	83	M10 x 1.0	Ford	1.8D	●	●		●						●
314259	83	M10 x 1.0	Alfa / Fiat / GM	1.9	●	●		●				●		
314266	126	M10 x 1.0	Audi	V6										
314267	162	M10 x 1.0	Nissan	2.2 / 2.5DCI		●		●					●	
314268	113	M10 x 1.0	Mercedes	CDi		●		●	●					
314269	134	M10 x 1.25	GM	1.7TD		●		●	●					
314271	145	M10 x 1.25	Toyota	2.0TD		●		●		●				
314274	102	M10 x 1.0	Renault / Nissan	1.5DCi	●	●		●					●	
314277	108	M8 x 1.0	Jaguar / PSA / Volvo	2.7D		●	●			●				
314285	76	M8 x 1.0	Ford / Land Rover	2.2TD4			●			●				
Dummy Injectors														
314219	190	–	Glow / Injector Ext			●								
314221	114	–	PSA / LTI Taxis	2.3 / 2.7DI										
314225	64	M24 x 2.0	Older Common Type	1.9 / 2.0 / 2.5	●			●						
314230	112	–	Stanadyne / Transit	2.5D										
314235	75	M20 x 1.5	Old Ford / Nissan	1.8 / 2.0 / 2.7	●			●						
314236	73	M22 x 1.5	Mercedes	2.0 / 2.3 / 2.5 / 2.9 / 3.0D				●						
314238	174	–	VW / Audi	1.9TDi										
314239	88	M24 x 1.5	Older Common Type	1.9 / 2.0 / 2.5				●						
314242	152	–	Land Rover	2.5 / 3.0TDi										
314244	104	–	Land Rover	2.5 CAV										
314245	118	M22 x 1.5	PSA / Rover	1.5				●						
314281	154	M22 x 1.5	Ford TDCi	2.0 / 2.2 / 2.4										●
314287	–	–	HDI Clamp Piezo			●								
314288	–	–	Clamp			●								
314730	–	–	Elbow Connector		●			●						

OIL PRESSURE TESTING

314700

Oil Pressure Test Kit

- Helps to diagnose worn oil pumps and engines, faulty oil pressure switches and pressure warning indicators
- Shock protected dual scale gauge for quick and accurate oil pressure checks
- Permanently oil primed, long flexible hose enables access to difficult to reach oil switch ports
- Small profile, quick coupling adaptors with built in shut off valve for fast secure connection
- Features a dual scale (0-10 bar / 0-150 psi) oil pressure test gauge meeting DIN16005, DIN16063 and BS1780 standards
- Includes a 1 metre oil primed hose and 10 x oil switch port adaptors
- Supplied in blow moulded case with foam insert

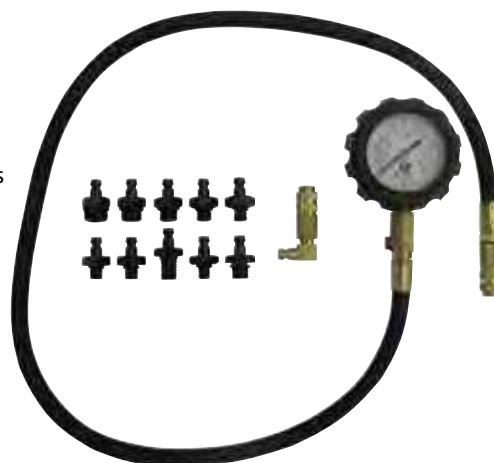

Contents

Part No.	Description	Thread
314701	Gauge Assembly	–
314730	90° Elbow Connector	–
314711	Adaptor No. 1	R1/8 DIN 2999
314712	Adaptor No. 2	1/8 x 27 NPT
314713	Adaptor No. 3	1/4 x 18 NPT
314714	Adaptor No. 4	3/8 x 20 UNF
314715	Adaptor No. 5	1/2 x 20 UNF
314716	Adaptor No. 6	M10 x 1.0
314717	Adaptor No. 7	M12 x 1.5
314718	Adaptor No. 8	M14 x 1.5
314719	Adaptor No. 9	M16 x 1.5
314721	Adaptor No. 10	M18 x 1.5



314702

Oil Pressure Test Gauge

- As per **314700** excluding adaptors
- Features a dual scale (0-10 bar / 0-150 psi) oil pressure test gauge meeting DIN16005, DIN16063 and BS1780 standards
- Supplied with extra long (2 metre) flexible, oil primed hose



CYLINDER HONING

028000

Cylinder Hone Kit 13-89mm

- Complete honing and deglazing set for 13-89mm diameter cylinder bores
- Designed for use on brake and clutch cylinders, motorcycle and small bore engine cylinders
- Flexible drive shaft for use with air or electric drills
- Supplied with **028002** medium grade 220 grit stone set



028100

Cylinder Hone Kit 50-180mm

- Complete honing and deglazing kit for 50-180mm diameter cylinder bores
- Ideal for use on passenger and light commercial vehicles with larger bore engine cylinders
- Features a robust, flexible drive shaft for use with air or electric drills
- Supplied with **028102** medium grade 220 grit stone set

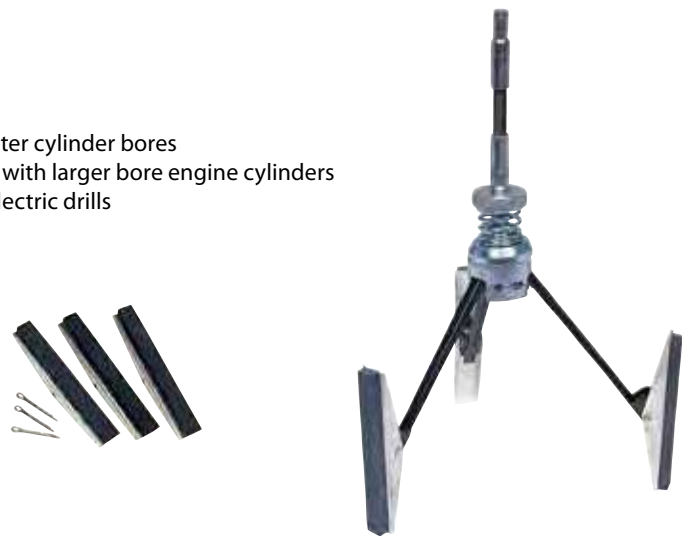

Stone Sets

- Sets below for use with **028000** Cylinder Hone Kit 13-89mm
 - Available in fine, medium or coarse hone stone sets
 - Each set contains nine grit stones (three of each size) in 19, 29 and 50mm lengths
 - Complete with replacement spring clips
- Sets below for use with **028100** Cylinder Hone Kit 50-180mm
 - Available in fine, medium or coarse hone stone sets
 - Each set contains three grit stones in 100mm lengths
 - Complete with replacement cotter pins

Part No.	Grit	Length (mm)	Qty
028001	Fine - 400 grit	19, 29, 50	9 (three of each size)
028002	Medium - 220 grit	19, 29, 50	9 (three of each size)
028003	Coarse - 100 grit	19, 29, 50	9 (three of each size)

Part No.	Grit	Length (mm)	Qty
028101	Fine - 400 grit	100	3
028102	Medium - 220 grit	100	3
028103	Coarse - 100 grit	100	3

PISTON RING COMPRESSING

Piston Ring Compressors

- High quality, ratchet action piston ring compressors
- Available in medium, large and large long reach configurations to suit a wide range of applications
- Spring assisted ratchet locking mechanism with square drive key

Part No.	Capacity (Ø mm)	Depth (mm)	Application
660370	57-125mm	80mm	For cars and light commercial vehicles
660373	90-175mm	80mm	For commercial vehicles, industrial and agricultural over square engines
032200	90-175mm	165mm	For large commercial vehicles, industrial and agricultural engines



VALVE REPAIR

039900

Valve Service Centre

- Comprehensive on-car valve spring compressing system
- Allows removal of valve springs and valve stem oil seals without removing the engine cylinder head
- Features a reversible, multi-position lever and fully adjustable pillar and beam assembly for extensive range of adjustment, allowing use on a wide range of OHV and OHC petrol and diesel engines
- Air holding adaptor allows engine cylinder to be pressurised via the spark plug port retaining the valves in their closed/sealed position during cylinder head servicing
- Collet sizes: 25mm, 30mm and 30mm restricted access type (half-moon)
- Beam length: 700mm
- Maximum beam height: 165mm
- Mounted on strong metal panel
- Includes:
 - 039650** Air Holding Adaptor
 - 039700** Valve Stem Seal Pliers
 - 039800** Valve Stem Seal Installer Kit
 - 670006** Telescopic Pick-up Magnetic

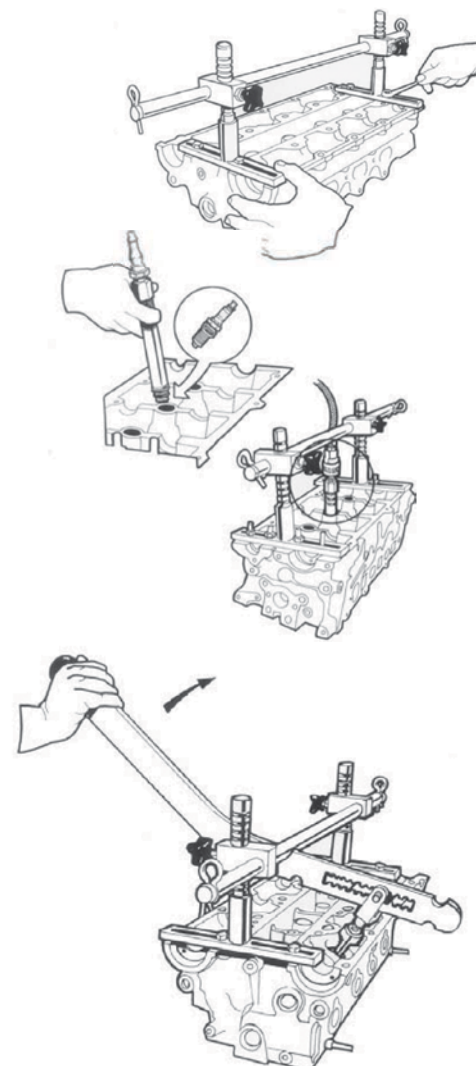

VALVE REPAIR cont.

039650

Air Holding Adaptor

- Allows engine cylinder to be pressurised via the spark plug port retaining the valves in their closed/sealed position during cylinder head servicing
- Features M14/M18 spark plug threaded end and long reach, knurled shaft to access deep seated plugs
- Standard connection to workshop airline
- 17mm square drive
- Overall length: 195mm



039700

Valve Stem Seal Pliers

- Speciality pliers specific to valve stem seal removal
- Uniquely shaped, long reaching ribbed jaws provide good access and grip at valve stem seal
- Minimum working range from 7mm diameter
- Maximum reach: 80mm
- Overall length: 275mm



039800

Valve Stem Seal Installer Kit

- Handy tool for accurately installing valve stem seals
- Contains four drive collets and three pilots to suit a wide range of applications
- Can be used with 039650 Air Holding Adaptor on car with valves in situ, or with valves removed
- Made from hardened plastic to reduce the possibility of damage to seals or engine components



Contents

Description	Internal Dia. (mm)	External Dia. (mm)
Drive Collet	12	17.4
Drive Collet	12.7	18
Drive Collet	15.5	20
Drive Collet	18	23.8
Valve Pilot	-	7
Valve Pilot	-	8
Valve Pilot	-	8.6

670006

Telescopic Pick-up Magnet

- Solid metal construction
- Strong magnetic tip capable of picking up small metallic objects
- Features telescopic shaft and in built pocket clip
- Extension range 135-490mm
- Holds weights up to 1.0kg



Valve Spring Compressors

- For use in the removal of valve springs, valves and stem seals during cylinder head servicing or repair
- Available in various cam lock lever designs for use on OHC, OHV, petrol and diesel applications
- Cam action design provides consistent parallel lift with automatic locking function
- Manufactured with reinforced frames from rust-proofed steel

Part No.	Application	Style	Jaw (A)		Throat (B)
			Min (mm)	Max (mm)	(mm)
038000	Large engines such as medium and heavy commercial vehicles	Offset	75	165	245
		Straight	95	186	245
039500	Multivalve engines (includes 25 & 30mm adaptors)	–	35	142	150
660210	Small to medium engines	–	70	135	150
660430	Overhead cam engines	–	63	129	158

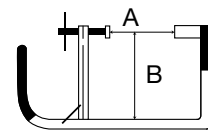

* Dimensions quoted are with tool fully compressed.



VALVE REPAIR cont.

017800

Cylinder Head Stands

- Designed to support engine cylinder head during off car servicing
- Two piece set comprising of base and pillar type stands manufactured from high quality mild steel
- Essential to provide secure footing and avoid damage to cylinder head when working on bench
- Fits stud holes from 9 – 18mm

Base (mm)	Pillar (Ø mm)	Taper (mm)
250 x 38 x 6	200	8 - 19

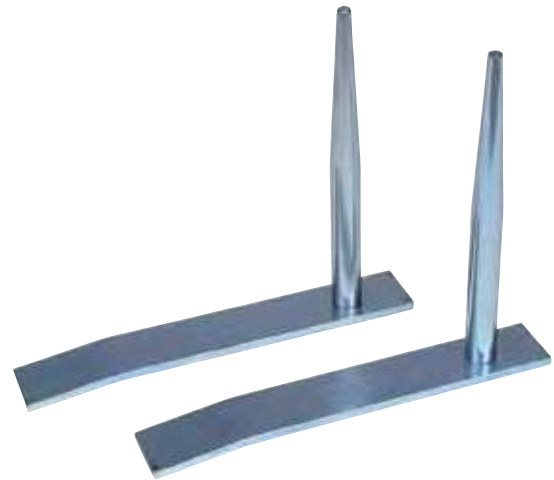

Valve Grinders/Lappers

- Feature wooden handles that are resistant to oil and grease, suitable for workshop conditions
- Three size rubber suction cups available in four configurations



Part No.	Style	Length (mm)	Cup Diameter (Ø mm)
660902	Single Ended	224	32
660903	Single Ended	224	22
660904	Single Ended	224	19
660905	Double Ended	224	19 and 22



016400

Feeler Gauge - Cranked

- Professional 26 blade, cranked feeler gauge set
- Features 45° offset for reach to areas where access is restricted
- Thickness range: 0.005 – 0.762mm



OIL FILTER REMOVAL

015500

Adjustable Strap Spanner

- Fully adjustable, heavy duty strap spanner for a wide range of garage workshop tasks
- Features a strong, cast iron handle for exerting high leverage and polyester webbing strap for tight, strong grip
- Capacity: 279mm
- Spares: **015512** Spare Strap



Oil Filter Removers - Band Type

- Strong non-stretch steel band with die cast screw mechanism
- Tool is looped over filter and tightened using one hand, ideal where access is restricted

038300

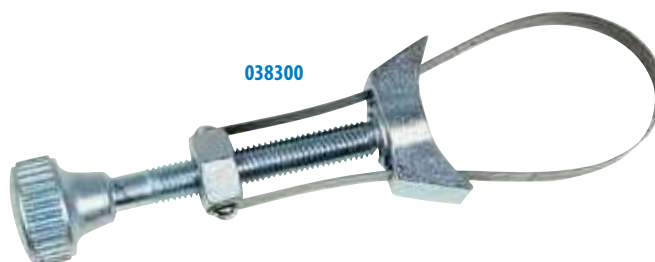

038400



Part No.	Suits	Capacity	Spare Band Part No.
038300	Heavy Commercial Vehicles, Plant etc.	110 - 155mm	038301
038400	Cars, Light Commercial Vehicles etc.	65 - 100mm	038401

038600

Oil Filter Remover - Strap Type

- For removing oil, fuel and water filters, gripping hubs and brake drums, removing exhausts etc
- Strong steel shank and tough polyester strap
- Compact design gives high leverage in restricted areas
- 13/16" hex, 3/8" and 1/2" square drive
- Self-tightening band designed for fast, secure filter removal
- Capacity: 300mm dia.
- Spares: **038605** Spare Strap



038900

Heavy Duty Oil Filter Remover - Chain Type

- For removing large oil, fuel and water filters on commercial vehicles, plant machinery, industrial engines etc
- Robust construction with mild steel shank and heavy duty leaf link chain
- 1" hex and 1/2" square drive
- Capacity: 150mm



ENGINE TIMING

316600

Timing Belt Tension Gauge

- For accurate tensioning of timing belts, minimising the risk of premature failure due to incorrect belt tension
- Features remote gauge for ease of access, with oil filled piston
- Gauge scale in Kg as recommended by vehicle manufacturers
- Supplied with calibration strip
- Suitable for use on all timing belts, v belts, industrial belts up to 12mm thick

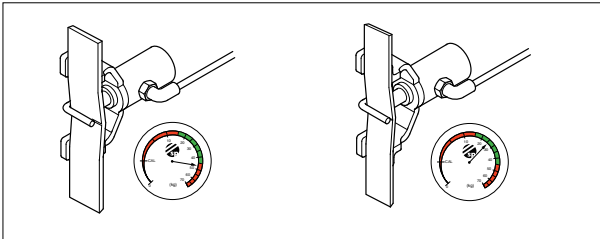

077524

Universal Sprocket Holding Wrench

- A multi-application wrench with variable adjustment
- Applications: diesel chain driven and diesel belt driven Ford Focus, Fiesta, Tourneo, Transit



077400

Flexible Drive Belt Stretcher

- Designed to be a safe, easy and versatile option for flexible drive belt fitment
- Multi-application tool performs the work of three standard belt stretching units



077444

Flexible Drive Belt Stretcher – Double Pulleys

- Specially designed two-piece tool for installing and dismantling stretch belts on double pulleys
- Ideal for double pulleys where the two pulleys are of different diameters
- Allows the belt to be installed in one operation
- Ideal for Ford Focus applications
- Threads: M8 x 1.25mm
- Bolt length: 80mm & 65mm



TRANSMISSION

085503

GM Gearbox Bearing / Race Remover

- For the removal of taper bearing cups from clutch housings in M32, MT 20-6 and MT 32-6 manual gearboxes
- Specifically designed to spread the load equally without danger of cracking the gearbox casing
- Applications: widely used in GM, Saab and Fiat Group



POWERTRAIN

013703

Universal Clutch Alignment Tool

- Convenient kit for quick and effective clutch alignment on modern front wheel drive vehicles
- Suits vehicles with flywheel fitting diameters 12 – 20mm, with or without pilot/spigot bearings
- Features parallel expanding supports in place of more traditional tapered fittings which can be difficult to keep located
- Easy to change adaptors suitable for clutch centre sizes 14.4mm to 29mm

**Contents**

Description	Size (mm)
Small cone	14.4 – 21mm
Large cone	20.9 – 29mm
Sleeves	12, 14, 15, 16, 17, 18, 19 & 20mm
Alignment tool	–

028300

Circlip Tool Set

- Uniquely designed T-handle circlip remover used to remove and replace circlip rings on pistons, gears and transmission components
- Enables internal and external operation with the threaded adjusting screw providing precise adjustment without the need to maintain hand pressure like most standard circlip pliers
- Includes four sets of interchangeable tips
- Jaw capacity: 44 – 178mm

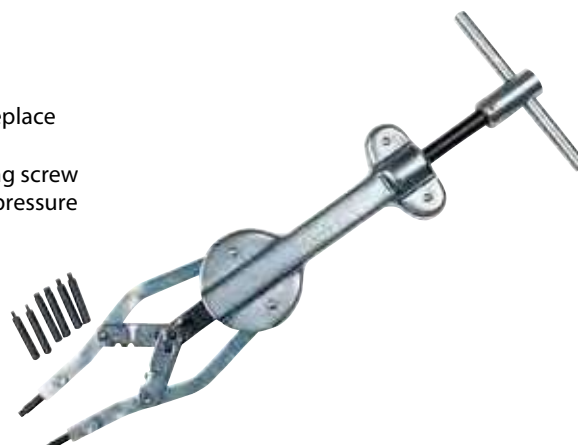

COOLING SYSTEM TESTING

331595

315 Series Cooling System Test Kit

- Provides extensive coverage for both popular and less popular models and is constantly updated as new models are released
- More than twenty specialist cooling system cap adaptors are available which act as a direct fit to the radiator or expansion tank
- Supplied with dual scale, 60mm diameter gauge and application listing
- All components of the '315' range are fully compatible with older SP Cooling System Kits and can be used to upgrade previous generations of Cooling System Pressure Test Kits which are fitted with quick-release connectors
- For older systems with a threaded connection, an adaptor is available **031868** Threaded Connection Adaptor
- All '315' Series cap adaptors are compatible with older Sykes-Pickavant Cooling System Kits:
to use with 317 series hand pump - no adaptors are required
to use with 318 series hand pump - adaptor **031868** is required



Contents

Part No.	Description	Hose Length (mm)	Gauge Dia. (mm)	Gauge Scale
331501	Hand Pump with Dual Scale Gauge	-	60	0-2.5 bar / 0-35 psi
331503	Hose Assembly with Quick Connector	600	-	-
Part No.	Description	Style	Qty	
See Page 25	Cooling System Adaptors	Threaded	16	
	Cooling System Adaptors	Bayonet	3	



315 Series Cooling System Tester - Optional Adaptors

Part No.	Applications	Image
331561	Mini Cooper S 2002 onwards	

Part No.	Applications	Image
331578	Dennis Dart PSV's, Optare Solo PSV's	

315 Series Cooling System Tester Adaptors

Part No.	Cap No.	General Applications	Image
331515	3	Chrysler, Citroen, Mercedes, Peugeot	
331567	4	Mazda, Suzuki, Toyota	
331571	5	Daihatsu, Honda, Hyundai, Kia, Mazda, Nissan, Suzuki	
331517	6	Chevrolet, Daewoo, Ford, GM	
331516	7	Alfa, Citroen, Fiat, Peugeot, Renault, Rover, Volvo	
331522	8	Seat, VW	
331535	9	Audi, Seat, Skoda, VW	
331548	10	BMW, Land Rover, Rover	
331512	11	Audi, Bentley, Porsche	
331555	12	Ford	

Part No.	Cap No.	General Applications	Image
331541	13	Mercedes	
331572	14	Ford	
331568	15	Ford, Jaguar, Volvo	
331563	16	Mercedes	
331565	17	BMW	
331556	18	Ford, Seat, VW	
331558	19	Toyota	
331575	20	Saab	
331573	21	Alfa, Ford, GM, Saab	
<p>Full application listing available to download at: www.tridon.com.au and www.spexport.co.uk</p>			

COOLING SYSTEM TESTING cont.

331900 & 331905

319 Series Cooling System Test Kits - Universal Expansion Plug System

These unique patented design Cooling System Test kits feature expansion plugs with a tapering rubber cone to fit a variety of radiator and header tank neck diameters. With a range of just five plug sizes, it is possible to cover a very wide range of applications, from small cars to commercial vehicles & heavy plant. Temperature testing can be carried out by using the thermometer in conjunction with the appropriate expansion plug and by observing the change (or lack of change) in the fluid temperature and by measuring the rate of change of temperature.

- Features a metal hand pump and precision gauge, with specially designed pressure release valve for safe de-pressurising of cooling systems
- A safety retaining clamp specially designed to provide added safety in certain applications by greatly reducing the risk of the expansion clamp slipping from its fixed position, particularly under high pressure in plastic expansion bottles, extreme cold or very high water temperatures
- Blanking caps are provided with both '319' series system testers in order to perform radiator sealing tests, off the vehicle
- Available in car or commercial vehicle kits designed to cover three types of system tests:
 - System Testing
 - Radiator Testing
 - Temperature Testing

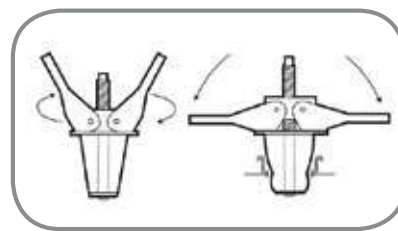

Expansion Plug



331900





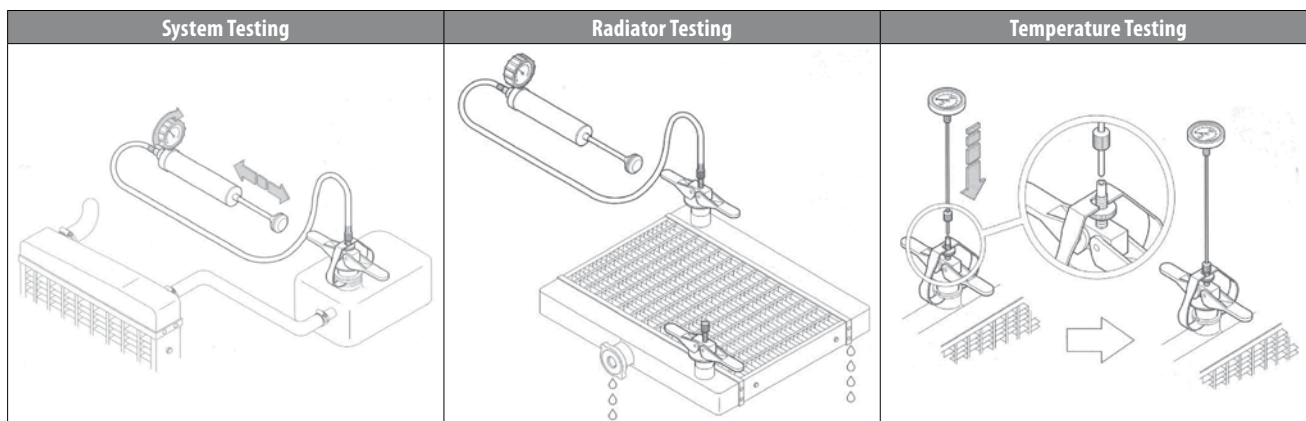





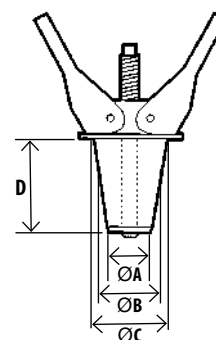

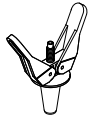
331905

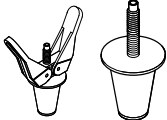

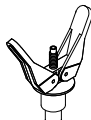
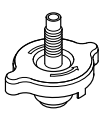
Specifications – Expansion Plug

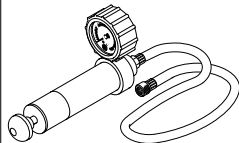
Part No.	D	ØA	ØA Expanded	ØB	ØB Expanded	ØC	ØC Expanded
03191100	70	21	24	30	32	38	38
03191200	70	27	29	35	37	42	42
03191300	70	33	36	41	44	50	50
03191400	70	40	44	53	56	65	65
03191500	70	27	29	40	42	44	44

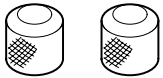

Spare Parts and Specifications				Kit Part No.	
				319 Series Car/LCV Kit	319 Series HGV Kit
Part No.	Description	Specification	Picture	331900	331905
031911	Expansion Plug	21-38mm		•	–
031912	Expansion Plug	27-42mm		•	–
031913 031933 – less handle	Expansion Plug	33-50mm		•	•
031914	Expansion Plug	40-65mm		–	•
031915	Expansion Plug	27-44mm Mercedes		Option	
031916	Bayonet Cooling Adaptor	Small Japanese / Korean		•	–
031925	Cooling System Thermometer	-7°C - 120°C (20°F - 248°F)		•	•
031930	Airline Adaptor & Gauge Connector	2 bar / 30 psi		–	•
031901	Pump Gauge & Hose Assembly	2 bar / 30 psi		•	–
031928	Nut			•	•
031921	Blanking Caps			•	•
031929	Safety Retaining Clamp			•	•

COOLING SYSTEM TESTING cont.

331400

HGV Cooling System Pressure Test Kit

- High quality HGV Cooling System Pressure Test Kit developed for popular vehicle makes such as DAF, Iveco, MAN, Mercedes, Renault, Scania and Volvo
- Features a high capacity, metal bodied hand pump with dual scale (0-2.5 bar / 0-36 psi) and quick-connect hose assembly
- Includes seven aluminium reservoir pressure caps designed to be direct fit to application
- Supplied in blow moulded case with vehicle application list



Contents

Part No.	Description	Cap Ref.	Internal Dia. (mm)	Application / Specification
331401	Pump & Gauge Assembly	–	–	0-2.5 bar / 0-36 psi
331403	Quick Connect Hose Assembly	–	–	545mm
331411	Reservoir Cap Adaptor	1	69	DAF – XF95, XF105 ERF - EC
331412	Reservoir Cap Adaptor	2	60	SCANIA – 94, 113, 114, 124, 125, 144, 164 , 4 Series
331413	Reservoir Cap Adaptor	3	42	VOLVO – FH12
331414	Reservoir Cap Adaptor	4	46	IVECO – Daily, 2000, C series RENAULT – Kerax, Magnum, Midlum, Premium
331415	Reservoir Cap Adaptor	5	52	MAN – E2000, F2000, L2000, TGA
331416	Reservoir Cap Adaptor	6	44	DAF – LF55 MERCEDES – Actros, Atego, Axor, Eco 8401 MAN – F90, F2000, TGA/L/M/S IVECO – Euro Star, Euro Tech, Euro, Trakker, Euro Strahlis VOLVO – FL, FM
331417	Reservoir Cap Adaptor	7	50	MERCEDES – Sprinter & Vito -2006 DEUTZ - 1015

331478

HGV Cooling System Pressure Tester - Optional Adaptor

Part No.	Applications	Image
331478	Dennis Dart PSV's, Optare Solo PSV's	

COOLANT/ANTI-FREEZE FLUID TESTING

032010

Refractometer

- This multi-purpose tool tests coolant battery acid, AdBlue and screen wash using an optical prism test technique
- Features internal light for use in poor light conditions
- Coolant – tests both propylene and ethylene based anti-freeze coolant solutions and determines the freezing point
- Battery acid – indicates the specific gravity of the battery electrolyte
- AdBlue – indicates % concentration of AdBlue additive
- Screen wash – shows the freezing point of screenwash fluids
- Freezing point shown in °C



Coolant	Battery	Windscreen	AdBlue
0 to -50 degrees C	1.1 to 1.4 kg/ltr	0 to -40 degrees C	30 m- 35%

032000

Professional Anti-Freeze Tester

- A quality instrument used to ascertain the volume percentage of ethylene glycol based coolants in an engine cooling system
- It works by showing the lowest temperature in °C to which the cooling system is protected



032002

Anti-Freeze Hydrometer – Polypropylene Glycol

- Anti-freeze/coolant hydrometer designed for modern aluminium alloy engines
- Modern aluminium alloy engines require a 'non-corrosive' antifreeze solution, hence polypropylene
- Features a dual scale gauge which measures the volume percentage of polypropylene glycol contained in the cooling system
- Temperature range -5°C to -40°C



331950

Combustion Leakage Tester

- An accurate and fast testing kit for diagnosis of cylinder head gasket leaks
- Essential tool for detecting the presence of combustion gases in the cooling system
- Suitable for use with both petrol and diesel engines
- Designed to be used in conjunction with **331595** '315' Series cooling system tester adaptors via the quick-connection fitting
- Can also be used in conjunction with older Sykes-Pickavant 317 series cap adaptors
- Supplied with both standard and sensitive reaction test fluid (250ml)
- Replacement bottles of reaction fluid available:
 - 331942** Standard - 250ml (white cap)
 - 331944** Sensitive - 250ml (black cap)



FUEL PRESSURE TESTING – SINGLE AND MULTI-POINT SYSTEMS

314860

Fuel Injection Pressure Test Kit – Single & Multi-Point Systems 

- Designed for diagnosis and testing of mechanical and electronic multi-point and single point fuel injection systems
- Features four connector sets with an extensive range of banjo fittings and connections, plus three hose coupler sets all to suit a comprehensive range of modern and older applications
- Includes four additional specific adaptors such as to fit the ‘self-test’ point on modern Ford and GM vehicles
- All fittings feature quick coupling adaptors with built-in shut-off valves for secure connections and efficient use
- Two shock protected and fuel resistant dual scale gauges feature convenient hooks for suspending under bonnet and relief valves for safe release of pressure
- Supplied in plastic case with foam insert



Contents

Part No.	Description	Length (mm)	Specifications
314871	Multi Point Gauge Assembly	290	0-10bar / 0-145psi
317872	Single Point Gauge Assembly	290	0-2bar / 0-30psi
314873	T-Connector & Tap Assembly	125	–
314855	Quick Connect Hose Assembly (2)	635	–
314827	Hose Coupling Set	300	1/4"
314828	Hose Coupling Set	300	5/16"
314829	Hose Coupling Set	300	3/8"
314802	Connector Set	varies	M8 x 1.0 – Male, Female, Long Male, Long Female, Banjo
314803	Connector Set	varies	M10 x 1.0 – Male, Female, Banjo
314804	Connector Set	varies	M12 x 1.0 & M12 x 1.5 Male, Female, Banjo
314805	Connector Set	varies	M14 x 1.5 – Male, Female, Banjo, Short & Long Conical
314830	Conical Adaptor	50	1/4" BSP
314876	Conical Adaptor	50	M16 x 1.5
314870	GM Adaptor	145	–
314880	Ford EEC IV Adaptor	145	–
314817	PGMFI Adaptor	68	–
314864	M6 Connector	50	M6 x 1.0
314885	System Connector (2)	350	Fiat, Alfa, Lancia Special Connectors
314890	System Connector (2)	350	Renault Special Connectors

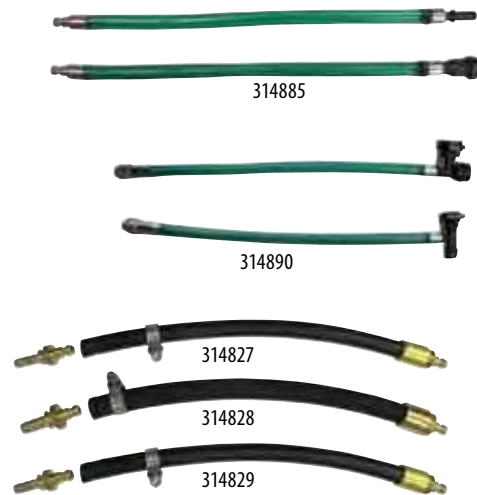

314875

Fuel Injection Pressure Test Kit – Multi-Point 

- Designed for modern electronic, multi-point fuel injection systems
- Assists in the diagnosis of common fuel injection faults such as no start, stalling and performance hesitation
- Includes T-piece with fuel tap, schrader valve connectors and hose adaptors for secure connections on modern applications
- All fittings feature quick coupling adaptors with built-in shut-off valves for secure connections and efficient use
- Shock protected and fuel resistant dual scale gauge features a convenient hook for suspending under bonnet and relief valve for safe release of pressure
- Supplied in plastic case with foam insert



Contents

Part No.	Description	Length (mm)	Specifications
314871	Multi Point Gauge Assembly	290	0-10bar / 0-145psi
314873	T-Connector & Tap Assembly	125	–
314863	Double Ended QR Hose Assembly	160	–
314818	Schrader Valve Connector	30	7/16"
314819	Schrader Valve Connector	30	7.7mm
314857	QR Schrader Valve Connector	40/90°	8mm
314885	System Connector (2)	350	Fiat, Alfa, Lancia Special Connectors
314890	System Connector (2)	350	Renault Special Connectors

314680

Combined Fuel Injection Pressure Test Kit  

- Designed for fuel pressure testing on modern multi-point petrol engines and low pressure systems on common rail diesel (CRD) vehicles
- This kit combines the applications from both:
314875 Multi-Point Petrol engine kit
314610 CRD Low Pressure Test Kit
- Features shock protected and fuel resistant dual scale pressure gauge with hook for suspending under bonnet, and relief valve for safe release of pressure
- Includes large dial vacuum gauge with hose and fittings, T-piece connector with fuel tap, and quick coupling adaptors and hose connectors



Contents

Part No.	Description	Length (mm)	Specifications
314871	Multi-Point Gauge Assembly	290	0-10 bar / 0-145 psi
314782	Vacuum Gauge & Hose Assembly	290	0-2 bar / 0-30 psi
314873	T-Connector & Tap Assembly	125	–
314885	Quick-Connect Hose Adaptors – Univ. (2)	350	8mm
314890	T-Connector Hose Adaptors – Renault (2)	350	10, 12mm
314880	Schrader Hose Adaptor - Ford EECIV	150	8mm
314870	Schrader Hose Adaptor – GM	150	7/16"
314615	Diesel Hose Connector Set (4)	280	1/4" Bore
		300	3/8" Bore



FUEL PRESSURE TESTING - SCHRADER VALVE CONNECTIONS

314895

Fuel Injection Pressure Test Kit – Schrader Valve Connections 

- Fuel pressure test kit containing three schrader test port adaptors and flexible quick-release (QR) hose for ease of access
- Where available, Schrader test ports are the preferred method of measuring fuel pressure on vehicles with fuel rails
- Provides a secure connection while being more efficient and easier to use
- Features shock protected and fuel resistant dual scale pressure gauge with hook for suspending under bonnet and relief valve for safe release of pressure
- Suitable for popular applications such as:
 8mm Schrader valve connector - fitted on BMW, Ford, Mini, PSA, VAG and Volvo models
 7/16 Schrader valve connector - fitted on Chrysler, Mercedes, Vauxhall and Opel models
 M8 QR Schrader valve connector - fitted on Alfa Romeo, Fiat and new Ford Ka
- Supplied in cardboard carton



Contents

Part No.	Description	Length (mm)	Specifications
314871	Multi-Point Gauge Assembly	290	0-10 bar / 0-145 psi
314863	Double Ended QR Hose	160	-
314818	Schrader Valve Connector	30	7/16"
314819	Schrader Valve Connector	30	8mm
314857	QR Schrader Valve Connector	40 / 90°	M8

Fuel Injection Schrader Valve Connector Kits 

- Schrader valve connector sets available separately for use with any SP Fuel Injection Pressure Test Kit
- Where available, Schrader test ports are the preferred method of measuring fuel pressure on vehicles with fuel rails due to the quick and secure connection
- Applications - as per **314895** Test Kit above
- Supplied in vinyl wallet



Part No.	Description
314850	Four Piece Set
314865	Two Piece Set

FUEL PRESSURE TESTING – VOLKSWAGEN AUDI GROUP (VAG)

314925

VAG Fuel Pump Pressure Test Kit – PD & FSI Engines

- Fuel pressure tester specially designed to suit “Pumpe Düse” (PD) and Fuel Stratified Injection (FSI) engines as used by the Volkswagen Audi Group (VAG)
- Features a shock protected, dual scale test gauge up to 20 bar as both PD and FSI engines operate at a higher pressure than conventional systems
- Includes special PD fuel pump quick connector, two FSI fuel pump connectors for 1.6, 1.8, and 2.0L FSI engines with Bosch fuel pumps and extra long (600mm) hose assembly for ease of access



Contents

Part No.	Description	Length (mm)	Specifications
314901	Pressure Gauge with Hose	600	0-20 bar / 0-300 psi
314814	PD Fuel Pump Adaptor	32	M12
314818	FSI Adaptor	29	Female
314878	FSI Adaptor	60	Male
314846	Banjo Bolt Assembly	40	M12 x 1.5 x 90°

314920

VAG Fuel Pump Pressure Test Kit – PD Engines

- Fuel pressure tester specially designed to suit “Pumpe Düse” (PD) engines as used by the Volkswagen Audi Group (VAG)
- Features a shock protected, dual scale test gauge up to 20 bar
- Includes special PD fuel pump quick connector and extra long (600mm) hose assembly for ease of access



Contents

Part No.	Description	Length (mm)	Specifications
314901	Pressure Gauge with Hose	600	0-20 bar / 0-300 psi
314814	PD Fuel Pump Adaptor	32	M12

FUEL & EXHAUST

FUEL PRESSURE TESTING – COMMON RAIL DIESEL (CRD)

314610

Common Rail Diesel (CRD) Low Pressure Test Gauge Kit

- Low pressure test gauge set for common rail diesel systems
- Measures low pressure feed from the fuel (lift) pump to the high pressure pump
- Also measures fuel return pressure where necessary
- Features a shock protected and fuel resistant, dual scale gauge with hook for suspending under bonnet, and relief valve for safe release of pressure
- Includes T-piece with fuel tap, Quick Connect (QC) hose adaptors 8 and 10mm (male and female), and Schrader valve connectors
- Helps to diagnose poor/non- starting, loss of engine power, blocked filters or fuel pipes
- Available with **314620** CRD Fuel Return Flow Kit as a combined set (**314600**) for a complete CRD low pressure test solution



Contents

Part No.	Description	Length (mm)	Specifications
314871	Multi-Point Gauge Assembly	290	0-10 bar / 0-145 psi
314873	T-Connector & Tap Assembly	125	-
314885	Quick-Connect Hose Adaptors – Univ. (2)	350	8mm
314615	Diesel Hose Connector Set (4)	280	1/4" Bore
		300	3/8" Bore

314620

Common Rail Diesel (CRD) Fuel Return Flow Kit

- Designed to assist in the diagnosis of CRD engine and fuel system faults by measuring the fuel return output of solenoid injectors
- Used on the injector return side of a CRD system to help diagnose symptoms such as poor or no engine starting, poor engine running, poor acceleration and general lack of engine power
- Features a compact six chamber acrylic block design with graduation scale for easy to read comparison across all cylinders
- Includes fuel resistant, highly flexible rubber hoses
- Suitable for use with Bosch, Delphi, Denso and Siemens solenoid injectors via clearly identifiable adaptors
- Supplied in a plastic case with foam insert and carry handle
- Available with **314610** CRD Low Pressure Test Gauge Kit as a combined set (**314600**) for a complete CRD low pressure test solution



Contents

Part No.	Description	Identifier	Qty
314621	Bosch Adaptor Set	C1	6
314622	Siemens Adaptor Set	C2	6
314623	Denso Adaptor Set	C3	6
314624	Delphi Adaptor Set	Plastic	6
314625	Rubber Hose Set	-	6
035700	Brake & Fuel Line Clamp	-	1

314600

Common Rail Diesel (CRD) Low Pressure Combined Kit

- A complete low pressure testing solution for common rail diesel systems
- Consists of:
 - 314610** CRD Low Pressure Test Gauge Kit
 - 314620** CRD Fuel Return Flow Kit

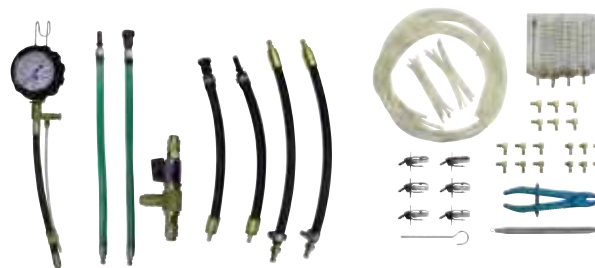

314650

Common Rail Diesel (CRD) High Pressure Fuel Test Kit 

- Designed to assist in the diagnosis of common CRD fault symptoms such as:
 - Poor or non-starting
 - Rough running (non-cylinder specific misfire)
 - Lack of power
 - Flat spots and/or hesitation on acceleration
- Enables measurement of delivery pressure output from the CRD high pressure pump (max 600 bar) under engine cranking conditions
- High pressure test gauge includes pressure limiting valve to prevent extreme pressure building in test kit and allows direct connection to the high pressure pump providing cranking pressure measurement of the pump
- Electronic sensor tester tests the high pressure sensor signal at the sensor allowing comparison to code reader component data (ECU vs Actual) with engine running
- Includes a selection of pipes and adaptors covering many applications with M12 x 1.5 / M14 x 1.5 connections
- Supplied with instructions in a protective blow moulded case

Contents

Part No.	Description	Length (mm)	Specifications
31465970	High Pressure Gauge Assembly	185	0-600 bar / 0-8,000 psi
300725	Digital Diesel Fuel Meter	–	12V, 0-5V input, 0-1500 bar
314651	Pipe Adaptor (male to male)	34	M12 x 1.5 (m) / M14 x 1.5 (m)
314657	Pipe Adaptor (female to male)	36	M12 x 1.5 (f) / M14 x 1.5 (m)
314652	Fuel Pipe	120	50° Bend
314656	Fuel Pipe	120	65° Bend
314653	Fuel Pipe	120	90° Bend x 70 x 50
314654	Fuel Pipe	120	90° Bend x 80 x 40
314655	Fuel Pipe	120	90° Compound Bend



Work with care on
CRD High Pressure
Fuel Systems

Pressure up to 1700 bar
max. (25,000 psi)

314660

CRD High Pressure Test Set 

- As per **314650** kit above excluding Electronic Sensor Tester (**300725**)
- Contains:
 - High Pressure Gauge 0-600 bar (0-8,000 psi)
 - 5 x High Pressure Fuel Pipes
 - 2 x Fuel Pipe Adaptors



Work with care on
CRD High Pressure
Fuel Systems

Pressure up to 1700 bar
max. (25,000 psi)

300725

Digital Diesel Fuel Pressure Meter 

- As per **314650** kit above excluding high pressure gauge and pipe components (**314660**)
- Uses voltage to measure the high pressure from the common rail pressure sensor by back probing signal wire under cranking and running conditions
- Ideal for making comparative pressure tests against ECU readings and actual rail pressure
- Converts signal to psi and bar
- Pressure range 0-1500 bar (22,000 psi)
- Operates on 12 volt supply



Work with care on
CRD High Pressure
Fuel Systems

Pressure up to 1700 bar
max. (25,000 psi)

VACUUM TESTING

013900

Vacuum System Tester

- For identifying faults on vacuum operated and controlled fuel and ignition systems, emission control systems and automatic transmissions
- Assists in the diagnosis of mechanical engine faults; checks fuel and vacuum pumps, vacuum advance/retard timing mechanisms, exhaust gas re-circulation systems, canister purge valves, fuel pressure regulators and MAP sensors
- Identifies leaks in fuel lines, air conditioning systems, heater cores, two stroke engine crankcases
- Features fully serviceable, precision die cast metal hand pump with dual scale gauge 0-76cm (0-30 ins) hg mercury
- Comprehensive range of tapered nozzles and manifold plugs for most vacuum test applications, including a 32mm rubber cap adaptor for obtaining vacuum where standard tapered nozzles are not suitable
- Supplied with three snap-over bleed nipple adapters plus 120ml reservoir jar for brake bleeding applications
- Complete with comprehensive instruction manual and storage case



Specifications

Max. Vacuum	Stroke Volume	Max. Pressure	Gauge Scale	Gauge Accuracy	Gauge Dia.	Overall Length	Reservoir Volume	Hose Length	Hose Dia.	In Line Reducer Dia.
23-25 hg 0-1 bar	1 cu.in.	60 psi 0-4 bar	0-76cm (0-30ins) hg	+/- 2% @ 20ins hg	53	235	120ml	610mm x 2	6.35	6.35 to 4.75

To upgrade for testing turbo charger waste gates: **013907** Compound Gauge Assembly

027600

Air Blow Gun

- Used for cleaning carburettor jets, fuel lines, brake pipes etc, the gun has an infinitely variable air flow with fingertip control and is also suitable for the dispensing of some low viscosity fluids
- High velocity 100mm nozzle, cranked for easy access
- High impact resistant body
- Body threaded 1/4" BSP to accept a quick coupler if required



DIESEL FUEL INJECTOR TOOLS

185800

Hydraulic Injector Puller Kit

- A unique concept designed specifically for the removal of stubborn or seized diesel injectors
- Provides controlled force to aid the removal of seized injectors where there is insufficient access for traditional slide hammers
- Uses a 12T hydraulic cylinder mounted to a multi-position frame with adjustable legs of different lengths, and a selection of mounting adaptors to allow alignment of the tool with the injectors
- Adjustable to be correctly positioned on most cylinder heads
- Supplied with injector adaptors for most modern injector types
- Includes injector solenoid and tamperproof socket set
- Supplied in blow moulded case with foam insert and instructional CD
- Requires the use of a porta power hydraulic hand pump sold separately
200170 Two Speed Hydraulic Hand Pump



Specifications – Hydraulic Cylinder

Stroke (mm)	Oil Capacity (C.C.)	Dia (mm)	Height (mm)	
			Retracted	Extended
8	14.8	73	60	68

Contents

Part No.	Description	Size (mm)	Length (mm)	Qty
SHS120	12T Hydraulic Cylinder	See table above		1
085814	Injector Adaptor	M14	39	1
085816	Injector Adaptor	M16	52	1
085817	Injector Adaptor	M17	52	1
085820	Injector Adaptor	M20	49	1
085825	Injector Adaptor	M25	42	1
085827	Injector Adaptor	M27	41	1
185801	Mounting Frame	300 x 300	20	1
185802	Support Legs	19	50	4
185803	Support Legs	19	100	4
185804	Support Legs	19	200	4
185805	Hex Head Bolt Mountings	17	20	4
185806	Hex Head Bolt Mountings	19	20	4
185807	Concave Head Bolt Mountings	15	20	4
185808	Tapered Cone Head Bolt Mountings	6	20	4
185809	Hex Injector Dismantling Tool	-	75	1
185810	Centre Spindle - Short	M16/M18	125	1
185813	Centre Spindle - Long	M16/M18	175	1
015125	Injector Solenoid Socket	25	100	1
015127	Injector Solenoid Socket	27	100	1
015129	Injector Solenoid Socket	29	100	1
015130	Injector Solenoid Socket	30	100	1
08585670	Tamperproof Socket	6 x 10	71	1
08585770	Tamperproof Socket	7 x 10	71	1



Hydraulic Injector Puller Add-On Kits

- Two 'add-on' kits designed specifically to operate with Sykes-Pickavant **185800** Hydraulic Injector Puller
- Ensures precise and correct tool alignment while reducing risk of damage to cylinder head
- Enables direct application of pulling force
- Kits include adaptor plates and support legs

Part No.	Description	Application
185825	Renault M9R Injector Puller Add-on	Nissan / GM 2.0L DCI (M9R)
185830	PSA Injector Puller Add-on	PSA 2.0L / 2.2L HDI



DIESEL FUEL INJECTOR TOOLS cont.

085700

Diesel Injector Puller

- Convenient and efficient injector puller for use with clamp-down injectors Lucas and Bosch type
- Features slide hammer mechanism with M8 x 0.75, M12 x 1.5, M14 x 1.5 & GM M17 adaptors
- Suitable for a wide variety of car, LCV & HGV applications with Lucas and Bosch type clamp down injectors
- M17 adaptor is ideal for GM Vauxhall/Opel injectors (X20DTH/Y20DTH series engines)
- Slide hammer weight: 0.5kg
- Overall length: 210mm



Injector Seal Extractors

- Designed specially to remove the copper injector base seal when it has become stuck in the cylinder head following removal of the injector
- Traditionally done using a 'pick' – these tools allow safe and easy removal without risk of damage to the cylinder head
- Suitable for both direct and indirect injected diesel engines - car, LCV, HGV
- Ideal for use when carbon deposits have caused the seal to become seized in place
- Available in split collet T-handle or heavy duty, tapered head slide hammer design



Part No.	Description	Operating Range (mm)	Overall Length (mm)	Slide Hammer Weight (g)
085810	Injector Seal Extractor – Split Collet, T-handle	6.4-8.0	215	–
085815	Injector Seal Extractor – HD Tapered Head, Slide Hammer	4.0-13.0	350	500

017500

Diesel Injector Seat Cutter Set

- Designed for the cleaning and/or cutting of injector seats and chambers when changing or reconditioning diesel injectors
- Helps to avoid 'blow-by' due to poorly seated injectors
- Includes:
 - Removal tool for copper washers
 - Injector blanking plugs to avoid debris entering the cylinders
 - Wire brush cleaning set for chamber walls
 - Centralising stem to improve correct cleaning seating angle



Contents

Part No.	Description	Length (mm)	Dia. (mm)	Face
01750170	Seat Cutter No. 1	38	17	Flat – 19mm dia. shank
01750270	Seat Cutter No. 2	38	17	Flat – 17mm dia. shank
01750370	Seat Cutter No. 3	38	15	Flat – 19mm dia. shank
01750470	Seat Cutter No. 4	38	17	120° – 21mm dia. shank
01750570	Seat Cutter No. 5	38	17	160° – 17mm dia. shank
017500-02	Top Cone & Spring Shaft Set	250 (Shaft)	24.5, 22, 20.5 (bushes)	–
017500-03	Pin & Plug Set	200 (shaft) 16 (bushes)	5 (shaft) 7 (bushes)	–
017500-04	Brush Set	2 x Long 2 x Short	9 (long) 20 (short)	–
085810	Injector Seal Extractor	215	6.5-8.0	–

314500**Diesel Injector Tester & Aspirator (DITA)**

- Mechanical pressure tester and aspirator for checking the correct operation of mechanical diesel injectors
- Tests nozzle opening pressure, injector spray pattern and correct needle seating
- Assists in the diagnosis of injector chatter and back leakage
- Suitable for testing all mechanical injectors with 12mm and 14mm screw fittings
- Bench mounted
- Safety features:
 - Mechanically damped gauge prevents over-pressurisation
 - Built-in aspirator removes test fluid spray away from the operator
 - Visual inspection of the injector spray pattern against mirrored disc
 - Safety viewing screen
 - Universal clamp for holding injectors securely whilst carrying out test procedures
 - Reservoir level indicator (test fluid can be re-used)
 - Complete with 12mm and 14mm quick-fit injector adaptors
- Designed to test for:
 - Nozzle opening pressure
 - Injector spray pattern
 - Injector condition and chatter
 - Injector back leakage and needle seating
- Use in conjunction with **314594** RITA (below) to test modern electronic diesel injectors

**Specifications**

Gauge Diameter	Gauge Scale	Max Injector Dia.	Injector Adaptor (2)	Handle Length	Clamp Spread	Height	Width	Depth
107mm	600 bar/ 8700psi	70mm	12 & 14mm	380	70	330mm	450mm	410mm

314595**Remote Injector Test Actuator (RITA)**

Modern diesel engines and injectors have increased in sophistication and in many cases operate via a signal from the engine control unit to an electronic trigger built in the injector. The Remote Injector Test Actuator (RITA) has been designed to operate as the trigger during modern injector testing.

- Designed to operate in conjunction with the **314500** DITA (above) to allow the spray pattern from suspect injectors to be observed
- Can generate pulses suitable to drive Piezo and non Piezo injector types
- Duration of the pulse and repetition rate can be adjusted to simulate a range of operating conditions
- Suitable for Bosch, Delphi, Denso and Siemens series of automotive common rail injectors
- Supplied complete with electrical mains cable and a universal connection cable to suit Bosch, Denso, Delphi, Piezo and general purpose applications
- No calibration required



314595



314595 & 314500

EXHAUST GAS TESTING

314400

Catalyst Back Pressure Tester

Many factors can cause an exhaust blockage causing general poor running and high fuel consumption. A visual inspection of the exhaust system is time consuming and often of limited use. The Catalyst Back Pressure Tester works by simply fitting into the oxygen (lambda) sensor port to measure the back pressure in the exhaust.

- Features a calibrated, dual scale gauge with colour coding to indicate a progressive pass/fail for idle and loaded tests
- Includes a 2m heat resistant gauge hose for dynamic testing
- Fits most European, Japanese and Asian vehicles with M12 x 1.25 and M18 x 1.5 oxygen (lambda) sensor ports
- Gauge scale: -1 to + 2 bar (-30 inHg to 30 psi)
- Spare Parts:
 - 314404 Optional Toyota Adaptor M12 x 1.25
 - 314415 Seals and Washers Service Kit



Tech Tip

Exhaust backpressure is vital for optimum engine performance. If exhaust flow becomes restricted it can cause a variety of poor performance symptoms.

Symptoms

- Poor engine performance
- Lack of high speed power
- Engine stall
- Poor fuel economy
- Increased engine operating temperature / overheating

Testing

The Sykes-Pickavant Catalyst Back Pressure Tester (314400) is equipped with a specialist low pressure test gauge and connectors to fit most modern vehicle lambda (O2 Sensor) ports.

A partially restricted converter, muffler or pipe may flow enough exhaust at idle not to cause a problem, but chokes breathing at higher engine speeds.

General Good Values

- @ Idle <1.5 psi
- @ 2000 rpm <3.0 psi
- @ 4000 rpm <4.0-8.0 psi

Test values will vary vehicle to vehicle depending on exhaust size, design and number of restrictors.

Contents

Part No.	Description	Specifications
314401	Pressure Gauge and Hose Assembly	-1 to + 2 bar (-30 inHg to 30 psi)
314402	Oxygen (Lambda) Connector	M18 x 1.5
314403	Oxygen (Lambda) Connector	M12 x 1.25
014105	Thread Restorer	M18 x 1.5
014106	Thread Restorer	M12 x 1.25

016900

Oxygen (Lambda) Sensor Socket Set

- For the fast and efficient removal of a variety of oxygen (lambda) sensors
- Sockets have recesses/windows to allow for sensor cables
- Manufactured from chrome vanadium/molybdenum with chemical black finish
- 3/8" square drive
- Seven piece set supplied in blow moulded storage case

Contents

Part No.	Size (mm)	Depth (mm)	Slot Width (mm)	Offset (mm)
016901	29	90	8	-
016902	22	90	21	-
019603	27	85	27 (window)	-
016904	22	80	8	-
016905	1 1/6"	75	-	-
016906	22	50	10	30
016907	22	30	8	55





CHASSIS

 Sykes-Pickavant®

BRAKES

BRAKE PIPE TOOLS

Flaremaster 2 – Flaring Tools

- Convenient and easy to use hand-held flaring tools
- Unique, original patented design for producing high quality pipe flares on the vehicle
- Flaring pipes on the vehicle allows for accurate repair sections following repair work or accident damage
- Fast-turn, coarse thread on hydraulic ram for quick assembly
- Locking bolt with swivel pin for fast tightening
- Enhanced bridge unit for greater strength
- Ergonomic handle moulding for greater comfort
- Available in stainless and mild steel pipe versions
- Supplied in blow moulded case
- Suitable for brake pipe sizes:
 - SAE Single and Double Flares – 3/16" and 4.75mm
 - DIN Single Flares – 4.75mm



Part No.	Description
027250	Flaremaster 2 – suits mild steel & copper
027297	Flaremaster 2 – suits mild and stainless steel

Spare Parts

Part No.	Description	Size
027251	Punch	3/16" and 4.75mm SAE Op1
027261	Punch	4.75mm DIN
027271	Punch	3/16" and 4.75mm SAE Op2
027204	Die Set	3/16" and 4.75mm DIN



Step 1 Place the pipe in the die



Step 2 Tighten the clamping nut



Step 3 Insert the punch and ram



Step 4 Turn T-Bar to create the flare

027266

Flaremaster 2-6mm Die Set Upgrade

- Designed to upgrade **027250** and **027297** Flaremaster 2 kits enabling flaring of 6mm (1/4") pipe

Contents

Part No.	Description	Size
027255	Punch	6mm SAE Op1
027262	Punch	6mm DIN
027244	Die Set	6mm SAE & DIN



027295

Flaremaster 2 – Brake Pipe Kit

- Comprehensive kit based on **027250** Flaremaster 2 for working with and manipulating mild steel brake pipe
- Contains four high quality brake pipe tools
- Enables pipe cutting, bending and flaring all with the pipe in-situ on vehicle
- Supplied in blow moulded case

Contents

Part No.	Description
027250	Flaremaster 2 (mild steel)
021600	Brake Pipe Aid Pliers
022100	Tube Cutter (3 – 32mm)
027300	Pipe Deburring Tool



270 Series Flaring Tools

- This popular flaring tool quickly and accurately produces convex and double lap flares to SAE and DIN standards on automotive brake and clutch pipes
- Features a unique 'Dial-a-Size' turret design and lever cam operation for quick flaring, see information over page
- Screw clamp for accurate die alignment and automatic punch extraction from flare provide the easiest of operation
- Five kits available to suit requirements



270 Series Flaring Tool Kit - Selection Chart

Kit Part No.	Flare Pattern	Tube Outside Diameter									
		3/16"	1/4"	5/16"	3/8"	1/2"	4.75mm	6mm	8mm	10mm	12mm
027000	SAE Convex Single	•	•	•	•		•				
	DIN Convex Single						•				
	SAE Double	•	•	•	•		•				
027001	SAE Convex Single	•					•				
	DIN Convex Single										
	SAE Double	•					•				
027002	SAE Convex Single	•					•	•	•	•	
	DIN Convex Single						•				
	SAE Double	•					•	•	•	•	
027008	SAE Convex Single	•	•	•	•	•	•	•	•	•	•
	DIN Convex Single						•				
	SAE Double	•	•	•	•	•	•	•	•	•	•
027009	SAE Convex Single	•	•				•	•			
	DIN Convex Single						•				
	SAE Double	•	•				•	•			



027000



027001



027002



027008



027009

BRAKES

BRAKE PIPE TOOLS cont.

270 Series Flaring Tools cont.

- Spare parts, replacement turret assemblies and individual punch and die component for use with 270 Series Flaring Tools
- Replacement punch and die components available individually, select from chart below

Spare Parts

Part No.	Description
027011	Body Assembly c/w 027014 Turret Assembly
027012	Body Assembly c/w 027015 Turret Assembly
027014	Turret Assembly c/w 3/16", 1/4" & 6mm, 5/16" & 8mm, 3/8" & 10mm, 4.75mm Op1 & Op2 Punches
027015	Turret Assembly c/w 3/16" & 4.75mm Op1 & Op2 Punches
027016	Turret Assembly c/w 1/2" & 12mm Op1 & Op2 Punches
027018	Turret Assembly c/w 4.75, 6, 8, 10 & 12mm Op1 DIN Punches
027025	Die Clamp Screw c/w 'T' Bar
027027	Handle



Turret Assembly

270 Series Individual Punch and Die Selection Chart

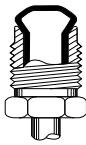
Flare Pattern	Tube O.D.	Punch Part No.	Die Set Part No.
SAE convex (single) 	3/16"	027051	027031
	1/4"	027052	027032
	5/16"	027053	027033
	3/8"	027054	027034
	1/2"	027055	027035
	6mm	027052	027042
	8mm	027053	027043
	10mm	027054	027044
	12mm	027055	027045

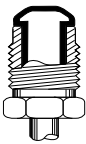
Flare Pattern	Tube O.D.	Punch Part No.	Die Set Part No.
DIN convex (single) 	4.75mm	027061	027041
	6mm	027062	027047
	8mm	027063	027048
	10mm	027064	027049
	12mm	027065	027050

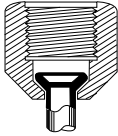
Flare Pattern	Tube O.D.	Punch Part No.	Die Set Part No.
SAE concave (double) 	3/16"	027051	027031
		027071	
	1/4"	027052	027032
		027071	
	5/16"	027053	027033
		027072	
	3/8"	027054	027034
		027072	
	1/2"	027055	027035
		027073	
	4.75mm	027051	027031
		027071	
	6mm	027052	027042
		027071	
8mm	027053	027043	
	027072		
10mm	027054	027044	
	027072		
12mm	027055	027045	
	027073		

Pipe Aid Pliers

- Specialist pliers for manipulating and forming brake and clutch pipe
- Can also be used for fast tube nut thread alignment and as a guide when cutting tube
- Slim, compact shape allows tight bends to be made in restricted areas

Part No.	Description	Suits Pipe Size Ø
021600	Pipe Aid Plier – Single Size	4.75mm (3/16")
021650	Pipe Aid Plier – Dual Size	4.75mm (3/16"), 6.00mm (1/4")



660925

Mini Tube Cutter 3-22mm

- Designed for cutting automotive brake and clutch pipe
- Suitable for cutting aluminium, brass, copper and mild steel tubing
- Capacity: 3–22mm tube



022100

Tube Cutter 3-32mm

- Designed for cutting automotive brake and clutch pipe
- Suitable for cutting aluminium, brass, copper and mild steel tubing
- Telescopic action and grooved rollers allow cutting very close to flared pipe ends
- Features fold-away deburrer and spare cutting wheel in handle
- Capacity: 3–32mm tube
- Spare Parts: **022101** Cutter Wheel (2 pack)



027300

Pipe Deburring Tool 3-15mm

- Essential tool when preparing to flare brake pipe, to avoid the risk of swarf in the pipe
- Double ended tool ideal for the deburring of brake, clutch and fuel pipes when preparing ends for use
- Suitable for deburring aluminium, brass, copper and mild steel tubing
- Capacity: 3mm (1/8") to 15mm (5/8")



BRAKES

BRAKE PIPE TOOLS cont.

027400

Pipe Deburring Tool – Internal/External

- Professional quality deburring tool for ensuring pipe and tubing are deburred effectively before fitting
- Features retractable tip to prevent damage to cutting tip
- Provides internal and external deburring capability
- Ideal for automotive brake, clutch and fuel pipes
- Suitable for copper, brass, steel, plastic and stainless steel pipe
- Capacity: Internal 3 - 12mm, External: 4 - 14mm



025600

Pipe Bender 4.75-6mm

- Rolling action pipe bender forms bends up to 180° without causing abrasion damage to pipe surface
- Ideal for plastic or epoxy coated pipes as well as copper, brass and mild steel
- Features convenient lug on handle for bench use with a vice
- Capacity: 4.75mm (3/16") to 6mm (1/4")



024600

Adjustable Pipe Bender 4.75-10mm

- Fully adjustable tool for forming perfect bends on pipes
- Unique design allows for infinite adjustment capability for all pipe size variations within the overall range
- Hand held operation for in-situ work
- Features convenient lug on handle for bench use with a vice
- Capacity: 4.75mm (3/16") to 10mm (3/8")



023400

Brake Pipe Corrosion Tool

- Designed to allow the user to inspect brake pipes for corrosion quickly and easily
- Features two scraper areas on the tool head to remove dirt and corrosion from pipes to effectively examine the condition of the pipes



BRAKE FLUID TOOLS

335300

Brake Fluid Tester

This kit tests brake fluid types Dot 3, Dot 4 and Dot 5.1. It works by comparing the boiling point of a sample of brake fluid taken from the vehicle against expected values selected from the internal menu.

Brake fluid is hygroscopic – increased absorption of water reduces the anti-corrosive effectiveness of the fluid and can cause brake fluid to boil with potential for complete brake failure. The tester simply indicates the boiling point of the sample and tells you the acceptable lower limit for each fluid specification (Dot 3, 4, 5.1).

- 12v operation can be used from the vehicle's own supply
- Suitable for DOT 3, 4, and 5.1 with boiling points up to 320°
- LCD screen displays battery voltage, brake fluid boiling point and simple pass or fail indicator
- Supplied in protective blow moulded case



034800

Vacuum Brake Bleeder

- Convenient air operated tool provides the ability to suck out old fluid from the brake master cylinder reservoir allowing new fluid to be added and bleed through instantly
- Uses standard workshop compressed air supply
- When combined with **034811** Auto Filler Unit, turns brake and clutch system bleeding into a genuine one man operation



034811

Auto Filler Unit

- Stand-alone brake fluid container for automatic filling of brake fluid reservoirs (space permitting)
- Air tight tap ensures fluid stays "fresh" for next time
- Removes the need for a second person to stand over the reservoir and keep it topped up
- Graduated scale gives an accurate indication of fluid usage
- When combined with **034800** Vacuum Brake Bleeder, turns brake and clutch system bleeding into a genuine one man operation



Brake Bleeder

- Brake bleeder bottles with transparent hose
- Features a non-return valve ensuring air does not return into the system thus enabling one-man operation
- Available in single or dual-circuit configurations



Part No.	Type
660500	Brake Bleeder – single circuit
660501	Brake Bleeder – dual circuit

BRAKES

BRAKE FLUID TOOLS cont.

Pressure Brake Bleeder Kits

- The **034900** and **034995** Pressure Brake Bleeders have been specifically designed to provide a ONE man operated tool for use in bleeding hydraulically operated automotive brake and clutch systems including anti-lock braking systems
- Convenient 12v power supply via red and black power cable to car battery
- Internal motor cuts in and out automatically to maintain optimal pressure during system bleeding
- System fluid level in the vehicle reservoir is automatically maintained during the bleeding process and upon completion via the bleeder unit reservoir
- Portable machine weighing only 4kgs making it ideal for the mobile mechanic or manoeuvring in a busy workshop
- Supplied with 60ml syringe for reservoir refill in restricted areas, 1000ml drain bottle designed with push-on bleed nipple connector and hanging chain for mess-free bleeding
- Offered in 'Euro' and 'Master' kit configurations
- Available reservoir cap adaptors
 - Modern European vehicle adaptor – M46 thread
 - Modern Korean vehicle cap adaptor – 50.7mm ID, 57mm OD
 - Multi-vehicle round adaptor – suits vehicles with round reservoir neck up to 85mm dia.
- Not suitable for mineral based brake fluids

Specifications – Bleeder Unit

Power	12 Volt
Fluid Capacity	1.25L
Hose Length	1.8m
Cable Length	2.4m
Operating Pressure	1-1.25 bar (14-20 psi)



034901

Part No.	Description	Specification	Kit Part No.	
			Euro	Master
034901	Brake Bleeder Unit	12volt	●	●
034980	European Screw Cap Adaptor	M46 thread	●	●
034992	Korean Cap Adaptor	50.7mm (ID), 57mm (OD)	–	●
034985	Drain Bottle	1000ml	●	●
034986	Syringe	60ml	●	●
034990	Multi-vehicle Round Adaptor	85mm Dia.	–	●
034982	Plastic Storage Accessory Case	–	–	●



034982



034980



034992



034990



034985



034986

034991

Oval Adaptor – Pressure Brake Bleed

- Multi-vehicle oval adaptor for use with **034900** or **034995** Pressure Brake Bleeder unit
- Suits vehicles with oval reservoir neck up to 65 x 120mm
- Ideal for Australian Falcon, Commodore



034991

BRAKE PAD AND DISC TOOLS

036130

Universal Brake Caliper Windback Tool

- Unique, universal 2 pin adjustable adaptor designed for caliper piston windback applications
- Features a 3/8" square drive for use with ratchet



Pin Dia. Ø	Min Pin Spread	Max Pin Spread
4mm	15mm	34mm

Brake Caliper Windback Kits

- Universal and applicated kits designed for brake caliper piston windback operation
- Features right hand and left hand windback thread to support both application types
- Supplied with **036130** Universal Brake Caliper Windback Tool
- Available in three configured kits
 - Universal starter kit – 4pc
 - Universal/Euro kit – 7pc
 - Master kit includes application list – 15pc

Contents			Kit Part No.		
			Standard	Euro	Master
Part No.	Description	Identifier	036150	036155	036192
036130	Universal Caliper Windback Tool		•	•	•
036190	RH Body & Screw	A	•	•	•
036191	LH Body & Screw	B	•	•	•
036103	Reaction Strap	C	•	•	•
036105	Drive Adaptor No. 1	D	-	•	•
036108	Drive Adaptor No. 2	E	-	-	•
036118	Drive Adaptor No. 4	F	-	-	•
036111	Drive Adaptor No. 11	G	-	•	•
036122	Drive Adaptor No. 14	H	-	-	•
036115	Drive Adaptor No. 15	I	-	•	•
036116	Drive Adaptor No. 16	J	-	-	•
036117	Drive Adaptor No. 17	K	-	-	•
036106	Drive Adaptor No. 18	L	-	-	•
036119	Drive Adaptor No. 19	M	-	-	•
036123	Drive Adaptor No. 23	N	-	-	•
036125	Drive Adaptor No. 25	O	-	-	•
036113	Drive Adaptor - 12mm		Available separately		



036150



036155



036192

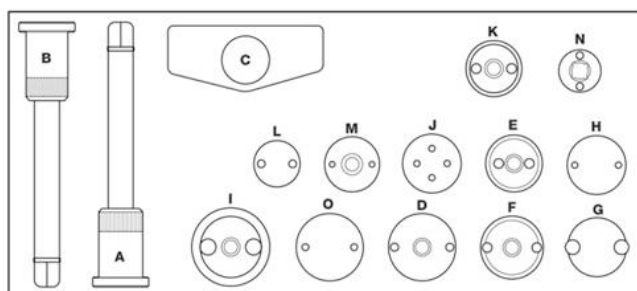

BRAKES

BRAKE PAD AND DISC TOOLS cont.

036198

Air Assisted Caliper Piston Windback Tool

- Uses existing workshop compressed air applied to ram while rotating the handle to return the caliper piston with very little effort
- Suitable for both left hand and right hand screw applications
- Supplied with **036108** Drive Adaptor to cover a wide range of popular vehicle applications
- Full range of additional specialist adaptors available (ref: **036194** below)
- 3/8" square drive



036108
Drive Adaptor

036194

Slimline Adaptor Set

- Set of seven special slimline adaptors for use with **036198** Air Assisted Windback Tool
- Special slimline design allows access where conventional wind back adaptors cannot fit
- Can also be used with conventional windback tools



076101

Brake Disc Run Out Set (Magnetic Base & DTI Gauge)

- Used for measuring disc run-out
- Powerful magnetic clamp with on/off lever for easy removal from surfaces
- Flat and 'V' shaped base can be used on both flat and round surfaces
- Simple and accessible fine adjuster for easy and precise settings

Contents

Part No.	Description
077120	High Quality DTI Gauge with floating scale
076100	Universal Magnetic Clamp for DTI with fine adjustment



660650

Hydraulic Hose Clamp

- Clamps brake and fuel hoses to allow brake/clutch slave cylinders to be disconnected or removed with minimum fluid loss



040101

Impact Driver Set

- For use with a medium weight hammer to loosen stubborn screws and nuts
- Ideal for removal of brake drum screws and door hinge brackets
- Supplied with a range of interchangeable bits

Contents

Part No.	Description	Size	Length (mm)
670650	Slotted Blade	5/16"	36
670652	Slotted Blade	3/8"	36
670654	Slotted Blade	1/2"	36
670660	X Point	No. 1	36
670662	X Point	No. 2	36
670664	X Point	No. 3	36
670666	X Point	No. 4	36
670512	Hex Bit	5mm	36
670514	Hex Bit	6mm	36
670518	Hex Bit	10mm	36
670596	Torx Bit	T30	36
670598	Torx Bit	T40	36
670600	Torx Bit	T45	36
670602	Torx Bit	T50	36



STEERING AND SUSPENSION

SPRING COMPRESSORS & STRUT

Coil Spring Compressors – Screw Type

- Designed with 'Tri Hook' configuration for the safe and efficient compression of coil springs on passenger and light commercial vehicles
- Features locking screw on threaded jaw to prevent slippage when under considerable load
- Enables fast tightening and releasing via Acme threaded screws
- Available in twin or triple pack
- 24mm hex nut drive

Part No.	Description	Max Operating Range	Safe Working Load (combined)
083800	Coil Spring Compressor – Twin Pack	270mm	9000N
083805	Coil Spring Compressor – Triple Pack	270mm	9000N



083900

Coil Spring Compressor – Vice Mounted

- Design for superior operation and safety when working with automotive coil springs
- Sykes-Pickavant unique 'tools for life' design supported by an extensive range of options and spare parts
- Features double ended 24mm hex drive which can be operated from either end for ease of use
- Both 24mm hex nut drives incorporate shear pins for safety
- Can be safely unwound in the event of shear pin failure
- Enables fast tightening and releasing via heat treated, self-lubricating Acme threaded screw
- Designed to suit most applications in the market via two sets of universal jaws
- Vice mount or on vehicle use
- Not recommended for use with impact gun



Specifications

Max Operating Range	Safe Working Load	Jaw Diameter Ø	
		Medium Jaws	Large Jaws
330mm	15000N	110-150mm	140-195mm

Contents

Part No.	Description	Specifications
083902	Medium Jaw – single	110-150mm
083903	Large Jaw – single	140-195mm
083917	Main Screw	–
083921	Main Nut – 2 pack	–
083924	Shear Pins – 6 pack	–
083930	Thrust Bearing	–
083931	Jaw Retaining Screw – 4 pack	M6 x 1.0
083932	Jaw Retaining Screw – 2 pack*	M10 x 1.5

* For use with 08400 Series Optional Jaws



STEERING AND SUSPENSION

Jaw Sets

- Optional specialist jaws for use with **083900** Coil Spring Compressor
- Supplied as singles and can be adapted for use on tapered coil springs
- Two sizes available

Part No.	Description	Size
083901	Small Jaw	80-150mm
083904	Extra Large Jaw	180-240mm



Jaw Covers

- Optional jaw covers for use with **083900** Coil Spring Compressor
- Available for small, medium and large jaw sizes

Part No.	Description
083911	Small Jaw Cover
083912	Medium Jaw Cover
083913	Large Jaw Cover

**083905**

Adaptor Kit

- Designed as add-on kit for use with **083900** Coil Spring Compressor
- Features spacer blocks and extensions
- Spacer block raises jaw height at one end to enable ease of use with asymmetric / tapered coil springs
- Each extension block will increase the overall operating range by 40mm (80mm total) to allow for extra-long strut assemblies

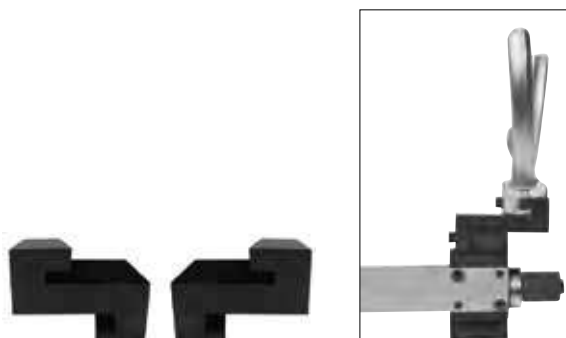
**083915**

Safety Cage

- Bench mounted safety cage designed for use with **083900** Coil Spring Compressor
- Roll-back screen mechanism provides easy access for location of coil spring compressor and coil spring
- Positive locking latch mechanism holds screen securely in place
- The screen covers the working area of the compressor when in operation
- Unit does not restrict vision while working on coil spring or strut assembly
- Robust design provides protection against personal injury should the spring break, or become dislodged under load
- A must for every workshop



STEERING AND SUSPENSION

SPRING COMPRESSORS & STRUT cont.

084500

Coil Spring Compressor – Internal

- Specially designed for vehicles fitted with front and rear wishbone suspension
- Designed to fit applications where the access hole in the lower wishbone is as small as 30mm diameter
- Supplied with two pairs of specialist jaws
 - Small jaws 90-120mm
 - Large jaws 120-140mm
- Unique torque stick extends functionality and adds safety
 - 100 Nm max torque
 - 1/2" square drive
 - Suitable for impact wrench usage
- TUV approved
- Supplied in storage case with full instructions and vehicle applications
- Applications - the Internal Coil Spring Compressor fits a wide variety of vehicles with wishbone suspension including:
 - BMW / Citroen / Chrysler / Ford / Honda / Hyundai / Kia / Mazda / Mercedes / Mitsubishi / Peugeot / Renault / Seat / Skoda / Suzuki / Toyota / Volvo / VW



Specifications

Maximum Load	2,500 kg (25,000 Nm)
Minimum Distance	96mm
Maximum Distance	220mm
Maximum Travel	124mm
Torque Stick Limit	10 kg (100 Nm)
Dimension Body (D x L)	Ø 29 x 225-280mm
Dimension Torque Stick (D x L)	Ø 27 x 180mm
Body Weight	0.64 kg
Torque Stick Weight	0.26 kg

Spare Parts

Part No.	Description
084505	Torque Stick (Safety Key) 100Nm
084515	Jaws 90 – 120mm (Set of 2)
084519	Jaws 120 – 140mm (Set of 2)
084501	Body Assembly

Application List

Vehicle Make & Model	Year	Jaw Part No.		
		Front	Rear	
BMW	1-series E87	07 -	–	084515
	2-series E90	07 -	–	084515
	3-series E91	07 -	–	084515
Citroen	C1	06 -	–	084515
	C3	03 -	–	084515
	C4	06 -	–	084515
	C8	03 -	–	084519
Chevrolet	Kalos	07 -	–	084515
Chrysler	300C	07 -	–	084515
Ford	Fiesta	02 -	–	084515
	Focus C-Max	03 -	–	084515
	Focus	07 -	–	084515
	Fusion	03 -	–	084519
Honda	Civic/Stream	07 -	–	084519
Hyundai	Getz	02 -	–	084515
	i 30	07 -	–	084515
	Sonata	01 -	–	084515
Kia	Carens, Ceed	07 -	–	084515
	Picanto	07 -	–	084515
	Rio	07 -	–	084519
Mercedes	C-CLASS W202	93-00	084515	–
	CL W140	93-99	084515	–
	CLK W209	03 -	–	084515
	E-CLASS W124	93-95	084515	–
	E-CLASS W211	02 -	–	084519
	M-CLASS	06 -	084515	–
	S-CLASS W116	73-80	084519	–
	S-CLASS W126	80-91	084515	–
	S-CLASS W140	91-98	084515	–
	W107, W114, W115, W123, W129, W201		084519	–
	Mazda	Mazda 2, 5	07 -	–
Mazda 3		03 -	–	084515
CX 7		08 -	–	084515
Mitsubishi	Colt	07 -	–	084515
	Pajero	07 -	–	084515
Peugeot	107	07 -	–	084515
	207	07 -	–	084519
	307	07 -	–	084515
	807	08 -	–	084519
	1007	07 -	–	084515
	308, 4007	08 -	–	084515
Renault	Traffic	07 -	–	084515
Seat	Cordoba	93 -	–	084515
	Ibiza	96 -	–	084515
Skoda	Fabia, Roomster, Octavia Scout	07 -	–	084515
	Octavia	01 -	–	084515
	Roomster Scout	08 -	–	084515
Suzuki	Swift, SX 4	07 -	–	084515
	Vitara	07 -	–	084515
Toyota	Auris	08 -	–	084519
	Aygo	07 -	–	084515
	Yaris	07 -	–	084519
Volvo	C 30, C 70, S 40	07 -	–	084515
	S 60	03 -	–	084519
	V 50	07 -	–	084515
	V 70, XC 90	07 -	–	084519
VW	Beetle, Fox, Polo	07 -	–	084515
	Touran	03 -	–	084515

084875

MacPherson Strut Controller

- Allows control over the strip down and re-assembly of shock absorbers fitted with internal rebound stop springs
- Ensures safe retaining of the piston rod in extended position
- Universal clamp features non-marking nylon jaws which clamp over the piston rod and stop it from being drawn back into the strut
- Telescopic handle and bearing assembly allow for correct assembly of new piston
- Supplied in protective foam padded case



084876

Universal MacPherson Strut Clamp

- Universal clamp features non-marking nylon jaws which clamp over the piston rod and stop it from being drawn back into the strut



STEERING AND SUSPENSION

SPRING COMPRESSORS & STRUT cont.

084800

MacPherson Strut Lifter

- Designed to quickly and safely lift bridge type MacPherson Struts (where the hub can be separated from the strut) without the removal of the ball joint and drive shaft
- Operates by exerting an upward force controlled by a hydraulic transmission jack through the strut, thereby constricting the spring. As the strut is forced upwards the hub and the rest of the suspension can be separated for improved access
- Suitable for front suspension bridge type MacPherson Struts on vehicles such as Peugeot 206, Citroen C3 and new Mini
- Makes suspension work quicker and easier when cars are raised on two post ramps or wheel-free lifts
- Mounts onto the top of a standard hydraulic transmission jack
- Fits both 24 and 30mm diameter transmission jack pistons
- Adjustable top frame allows for secure fixing onto the strut to be lifted
- Tool is left and right handed allowing easy mounting and adjustments in size to fit various vehicle requirements



084850

Hub & Knuckle Clamp Spreader

- Spreads the steering knuckle to enable safe removal and assists re-assembly of shock absorbers, without risk of damage to the knuckle
- Adjustable - use with knuckles which have either a centralised or non-centralised slot
- Suitable for use on both single and twin knuckles:
 - Single knuckles as found on a wide range of vehicle models
 - Twin knuckles as found on modern VAG models
- Ideal companion product when using **084800** MacPherson Strut Lifter in order to release the lower end of the strut from the suspension arm



STEERING AND SUSPENSION

BALL JOINT SEPARATORS

080500

Ball Joint Separator – 4 Way Adjustable

- Designed to enable ball joint removal on a wide range of passenger and light commercial vehicle applications
- Unique adjustable design provides four jaw opening configurations via the quick release central pin and reversible lever
- Features tapered, slim jaw fork for tight access applications
- Tough black epoxy coating

Jaw Opening	Throat Depth	Overall Length
24, 30, 40, 45mm	30mm	158mm



CHASSIS

660550

Ball Joint Separator

- Simple and specific tool for ball joint removal
- Ideal for one-size efficient use on passenger vehicles and some light commercials

Jaw Opening	Throat Depth	Throat Width
45mm	30mm	19mm



660310

Ball Joint Separator – Direct Action

- Simple ball joint removal tool applies direct force to ball joint screw
- Suitable for most popular passenger vehicle applications

Jaw Opening	Throat Depth	Throat Depth
50mm	19mm	20mm



STEERING AND SUSPENSION

BALL JOINT SEPARATORS cont.

Ball Joint Separator – HGV

- Enables ball joint separation and removal on heavy goods vehicles
- Heavy duty manufacture with strengthened lever and fork allowing for greater force to be applied
- Manufactured from alloy steel SCM 440
- Available in mechanical screw or hydraulic (8 tonne ram) configurations
- Hydraulic upgrade kit available for customers who previously purchased the mechanical screw unit **080750** Hydraulic Upgrade Kit

Part No.	Description	Jaw Opening	Throat Width	Throat Depth
080700	Ball Joint Separator – Mechanical Screw	70mm	36mm	50mm
180700	Ball Joint Separator – Hydraulic	70mm	36mm	50mm
080750	Hydraulic Upgrade Kit			



Ball Joint Separator – Fork Type

- Effective and simple ball joint separation and removal
- Durable drop forged steel design enables hammer strike operation
- Suitable for passenger and light commercial applications
- Available in short and long lengths

Part No.	Throat Width	Throat Depth	Overall Length
660490	19mm	69mm	195mm
080600	18mm	88mm	420mm



050500

Impact Pitman/Drop Arm Puller

- Heavy duty puller for the removal of Pitman/drop arms from the toughest of vehicle applications
- Suits Land Rover Discovery 1 & 2, Range Rover P38, Land Rover Defender and Ford Transit
- The puller is designed to be used with the steering box already removed from the vehicle
- Includes an impact force screw allowing the technician to effectively shock the Pitman/drop arm loose from the steering box
- Spare Parts -
127311 Impact Forcing Screw
082519 Shock Handle

Puller Spread Max	Puller Reach Max
60mm	80mm



HUB PULLERS & BEARING TOOLS

Fixed Plate Hub Puller Kits – Car, LCV

- Fix Plate Hub Puller for cars and light commercials, featuring **085308** Hub Puller Plate which has been specially designed to meet the application requirements of modern vehicles
- Features a specially enlarged central dome to accommodate larger wheel hub caps (eg. Ford Focus) as found on many modern vehicles
- Designed with an extended spread pattern, to accommodate up to 160mm stud circle diameters
- Available in three configurations depending on the user requirements
 - Mechanical with converter and forcing screw
 - Hydraulic with 1500 Series 8 tonne hydraulic ram
 - Slide Hammer with converter and 1.6kg slide hammer unit
- Option to add additional components

Specifications – Hub Puller Plate

Hub Centre Diameter	70mm
Hub Centre Depth	65mm
Min. Pitch Circle Dia.	100mm
Max. Pitch Circle Dia.	160mm
Centre Hole Screw Thread	1½" x 16 Tpi



085308



085300
Mechanical
Puller

Part No.	Description	Specification	Kit Part No.		
			Mechanical	Hydraulic	Slide Hammer
085308	Hub Puller Plate	See table above	1	1	1
085312	Hub Puller Plate Mechanical Converter	1½" x 16 Tpi (Ext. Thread) 5/8" UNF (Int. Thread)	1	-	1
085311	Mechanical Forcing Screw	5/8" UNF x 4" 24mm Hex Drive	1	-	-
085307	Slide Hammer	5/8" UNF, 1.6kg	-	-	1
150000	Hydraulic Ram	8 Tonne force	-	1	-



085316
Hydraulic
Puller



085306
Slide Hammer
Hub Puller

STEERING AND SUSPENSION

HUB PULLERS & BEARING TOOLS cont.

Fixed Plate Hub Puller Kits – Heavy Duty

- Two universal Fixed Plate Hub Puller Kits designed for cars and light commercials where a heavy duty tool is required
- Featuring **185001** Hub Puller Plate designed with pitch circle of 90 – 170mm to meet a wide range of modern applications
- Comprehensive range of colour coded extended nuts and studs provide clearance for modern hub caps and bearings
- Stud and vehicle application chart provided
- Available in slide hammer (4.5kg) or hydraulic ram (8 tonne) configurations

Part No.	Description	Specifications	Effective Length	Kit Part No.	
				Hydraulic	Slide Hammer
085309	Heavy Duty Slide Hammer	4.5kg	–		1
150000	1500 Series Hydraulic Ram	8 Tonne	–	1	–
152422	Ram Extension	–	2"	1	–
185001	Hub Puller Plate	–	–	1	1
185002	Ram Convertor c/w Locking Nut	–	–	1	1
185004	Shoulder Nuts	–	–	4	3
185007	Stud	M14 X 1.5	100mm	4	3
185008	Extended Nut	M12 X 1.25	100mm	4	–
185009	Extended Nut	M12 X 1.5	100mm	4	3
185010	Extended Nut	M16 x 1.5	100mm	–	3
185011	Stud	M18 x 1.5	100mm	–	3
185019	Stud	M14 x 2.0	100mm	–	3
185021	Stud – double ended	M12 x 1.25 & M12 x 1.5	100mm	4	3

Contents



082545

Hub & Front Wheel Bearing Removal Kit – Ford Transit

- Specialist slide hammer tool kit designed to provide three hub and bearing pulling solutions in one
 - Traditional hub pulling
 - Reverse slide hammer for outer race bearing pulling
 - Effective inner race bearing pulling
- Features dual action, heavy duty slide hammer which operates in two directions to achieve multiple operations
- Suits Ford Transit Mk6 & Mk7 hub and front wheel bearing removal
- Bearing separator capacity: 20-105mm
- Slide Hammer:
 - Weight: 5.7kg
 - Length: 800mm

Spare Parts

Part No.	Description
082545-01	Nut & Washer pack
082545-02	Ring (1)
082545-03	Legs (5) includes nuts pack
095100	Bearing Separator Assembly



Hub Removal



Outer Bearing Removal



Inner Bearing Removal

STEERING AND SUSPENSION

HUB PULLERS & BEARING TOOLS cont.

Adjustable Hub Pullers – Car, LCV

- Comprehensive range of mechanical and hydraulic hub pullers to suit passenger and light commercial vehicles
- Manufactured with free moving legs mounted on a floating plunger enables quick and easy attachment to vehicle hubs
- 3 or 5 leg configurations provide up to 203mm of spread with a hole size suitable for studs up to 15.8mm in diameter
- Available as a combined kit or with a choice of:
 - Heavy duty hammer type handle for shock force use, or
 - 1500 series hydraulic ram for smooth, progressive force up to 8 tonne
- All configurations feature a fine pitch outer thread for micro adjustment
- Manufactured from heat treated, drop forged steel
- Option to add additional legs



Contents	Part No.	Description	Length (mm)	Kit Part No.				
				Mechanical	Mechanical	Hydraulic	Hydraulic	Mechanical & Hydraulic
				082503	082505	127303	127305	127306
	082514	Leg	158	3	5	3	5	5
	127311	Force Screw	285	1	1	–	–	1
	082519	Shock Handle	203	1	1	–	–	1
	127312	Plunger Body	100 Dia.	1	1	1	1	1
	150000	Hydraulic Ram	–	–	–	1	1	1
	152422	Ram Extension	50	–	–	1	1	1



082503



082505



127303



127306

Adjustable Hub Pullers – Commercial Vehicle

- Specially designed free moving legs provide up to 305mm of spread with hole size suitable for studs up to 22mm in diameter
- Heavy duty hammer type handle with fine pitch force screw allows for use of shock force for tight and troublesome applications
- Manufactured from heat treated, drop forged steel
- Available in 3 and 6 leg configurations
- Option to add additional legs or upgrade to hydraulic style

082214 Leg (1)

150000 1500 Series Hydraulic Ram

152422 Ram Extension (50mm)



082203



082206

Contents	Part No.	Description	Length (mm)	Kit Part No.	
				082203	082206
	082214	Leg	211	3	6
	127311	Force Screw	285	1	1
	082519	Shock Handle	203	1	1
	082212	Plunger Body	152 Dia.	1	1

STEERING AND SUSPENSION

085309

Slide Hammer

- Heavy duty 4.5kg slide hammer can be used with the full range of Sykes-Pickavant hub pullers to remove hubs and half shafts quickly and efficiently

**Specifications**

Description	Length (mm)	Stud Hole Diameter	Thread	Hammer Weight
Hammer	165	100		4.5kg
Shaft	838	–	M20 x 2.5	–
Adaptor	40	–	M20 (int.), 1 1/2 whit (ext.)	–

081000

Universal Bearing Ring Puller

- Universal tool for the removal of bearings, races and sleeves
- Patented design with unique jaws removes the need for cutting tools and greatly reduces time required
- Legs cut and are pressed into the radius behind the ring as force is applied evenly
- Suitable for bearings / rings 40 – 60mm



084850

Hub & Knuckle Clamp Spreader

- Spreads the steering knuckle to enable safe removal and assists re-assembly of shock absorbers, without risk of damage to the knuckle
- Adjustable - use with knuckles which have either a centralised, or non-centralised slot
- Suitable for use on both single and twin knuckles:
 - Single knuckles as found on a wide range of vehicle models
 - Twin knuckles as found on modern VAG models
- Ideal companion product when using **084800** MacPherson Strut Lifter in order to release the lower end of the strut from the suspension arm



STEERING AND SUSPENSION

HUB PULLERS & BEARING TOOLS cont.

Hydraulic Truck Wheel and Hub Puller

- This unique wheel and hub removal solution has been specifically developed for the truck servicing and repair industry
- 12 Tonne hydraulic pump with a series of unique chains and attachments provide the ability to remove truck wheels and hubs which have become seized over time due to road grime and general operation
- Supplied in a durable metal case for convenient storage or secure transportation
- The metal case can be fixed to the mobile trolley attachment which is ideal for rapid workshop use
- Available in three configurations to cater for varying customer requirements, repair centres and mobile workshops



Wheel Pulling

- Designed for the removal of 10 stud 22.5" HGV wheels and associated axle hubs
- Suitable for pulling inner and outer wheels on twin or single wheel hubs
- Equal load distribution is achieved via 4 high strength chains allowing 2, 3 or 4 point pulling
- Hook system incorporates four hook types designed for internal and external pulling applications
- Plastic coated hook set provides protection for use on alloy and polished wheels
- Centre spigot frame assembly features two ring sizes and covers most popular applications
 - 281mm centre hole dia.
 - 221mm centre hole dia.
- Locates on the spigot lugs on the hub or can push against hub cover bolt heads
- Reversible beam to provide extra adjustment

Hub Pulling

- Contains a set of four shorter chains for close proximity to hub
- Four eyelet hooks designed specifically to attach to the hub wheel studs
- Ram nose piece applies force to the end of stub axle
- Two nose extension pieces to suit various hub configurations



208760 Hub Puller Add-on Kit



Pusher Cage and Ring



Aluminium Rim - Hooks

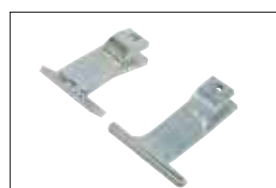

Steel Rim - Hooks



Hub Puller - Hooks

STEERING AND SUSPENSION

Contents

Part No.	Description	Kit Part No.		
		Wheel Puller	Wheel Puller with Trolley	Combined Wheel & Hub Puller
		208700	208750	208795
208710	12 Tonne Hydraulic Pump	1	1	1
208711	Locking Ring	1	1	1
208712	Flame Cut Beam	1	1	1
208713	Chains with Clevis Pins	4	4	4
208714	Chain Connecting Pin	2	2	2
208715	R Clips	8	8	8
208716	Steel Rim Inner - Hooks	4	4	4
208717	Steel Rim Outer - Hooks	4	4	4
208722	Aluminium Rim Outer - Hooks	4	4	4
208724	Aluminium Rim Inner - Hooks	4	4	4
208718	Pusher Cage Top Plate	1	1	1
208719	Pusher Ring Large	1	1	1
208720	Connecting Rods	4	4	4
208723	Spigot Bung Assembly	1	1	1
208721	Pusher Ring Small	1	1	1
208782	Metal Box	1	1	1
208730	Mobile Trolley Attachment	Option	1	1
208725	Hub Puller - Hooks	Option 208760 Hub Puller Add-on Kit		4
208726	Hub Puller - Nose Piece			1
208727	Hub Puller - Nose Piece Extension - 2 Piece			1
208728	Hub Puller - Chains with Clevis Pins (7 Link)			4

Mobile Trolley 208730

- Enables rapid workshop use
- Provides additional support during wheel or hub removal
- Storage case mounts for secure storage and transportation



DIAGNOSTIC

300475

Wireless Electronic Stethoscope – 'ChassisEar'

Designed for the detection of vehicle noises e.g. rattles, squeaks and air ingress under load, during a road test and for the diagnosis of a wide variety of potential faults e.g. wheel bearings, CV joints, differentials, transmission, injectors, alternators, water pumps, AC compressors and many more.

- Suitable for cars, vans, trucks, buses etc. as there are no cable length issues to overcome
- Pick-up clamps can be attached to many different parts of the vehicle in order to amplify the sounds made under load and in actual driving conditions
- Consists of receiver unit, 4 x transmitter units (4 channels), 4 pick-up leads, pick-up fixing straps, headphones, batteries, instruction manual & storage case

N.B. Due care and consideration should be taken of driving conditions and regulations when operating the ChassisEAR on the road.

Spare Parts

Part No.	Description	Qty
30047501	Transmitter 1	1
30047502	Transmitter 2	1
30047503	Transmitter 3	1
30047504	Transmitter 4	1
30047506	Pickup Lead and Clamps	4



WHEEL AND TYRE

660740

Tyre Pressure Gauge – Dial

- Straight nozzle, dial type tyre pressure gauge
- Features dual scale (bar/psi), shock protected 62mm gauge
- Manufactured to BS EN 12645 standards



Dual Scale	Gauge Dia.
0-3.5 Bar / 0-50 psi	62mm

660745

Tyre Pressure Gauge – Pencil

- Metal construction, pencil type tyre pressure gauge
- Features valve core remover, pocket clip and dual scale gauge



Dual Scale	Length	
	At Rest	Extended
0.5-3.4 Bar / 6-50 psi	120mm	156mm

800820

Tyre Pressure Monitoring System (TPMS) Torque Kit

- Ideal tool set to ensure critical torque settings are correct when servicing TPMS systems on modern and premium vehicles
- Contains tools required for servicing and replacing TPMS valve cores and nuts
- Features two torque screwdrivers with a combined range of 0.1 – 10.0Nm
- Supplied in protective foam tray
- See page 104 for kit contents



Torque Screwdriver		T-Bar Handle	Valve Core Tool	Torx Bit	Deep Socket	
0.1-3.0Nm	2.0-10.0Nm	3/8" sq dr	1/4" sq dr	T10 - 1/4" sq dr	11mm - 1/4" sq dr	12mm - 1/4" sq dr

032800

Tyre Tread Depth Gauge

- Pocket-sized tread depth gauge with convenient pocket clip
- Metal construction featuring clear, 1mm incremental gauge including 1.6mm depth measurement for MOT regulations
- MOT inspection approved



Scale	
0-26mm	1mm increments

076500

Digital Tyre Tread Depth Gauge

- Pocket-sized tread depth gauge
- Hardened and tempered stainless steel gauge with large LCD display
- Metric or imperial read-out including zero setting
- Range: 0-25mm / 0-1"



Dual Scale	Accuracy	Battery
0-25mm / 0-1"	± 0.05mm / 0.002"	SR44 / LR44



BODY

 Sykes-Pickavant®

BODY REPAIR PREPARATION & MAINTENANCE

Before any repair procedure is carried out, it is important that both inner and outer surfaces to be worked on are thoroughly cleaned. This panel preparation will make using these tools more effective and reduce wear and tear on the dollies and spoons. Hammers are very hard and, if misused either accidentally or otherwise, may easily chip causing flying splinters.

The condition of all tools should be constantly maintained and checked, eg a hammer shaft must be secure, there must be no cracks in the striking faces or chips of any description. Do not shorten an existing shaft if cracked or broken as this will affect the balance - replacement shafts are available for all Sykes-Pickavant beaters. All bright surfaces must be kept clean and free from blemishes that could be transferred to the body panels.



HAMMERS - CHOOSING AND USING



Beaters - the operation of beating metal is the greatest skill in body repair. The ability to control the intensity of the blows, together with the knowledge of how and where to direct them, is the mark of the expert. Beaters should be well balanced as the force delivered to the metal surface will depend on the weight of the beater, the weight and size of the dolly or spoon and the area of actual contact with the panel.



Shrinking Beaters - useful in the final stages of panel finishing when slightly stretched areas of metal can be encountered.

In using this type of beater, small amounts of metal are forced into the spaces created by the cross milling. They can also be used on cold aluminium, but working on sheet steel will be quicker if heat is applied to the area. Whenever possible, such beating should be carried out on the inside of the panel to minimise resurfacing needed prior to painting.



Mallets - rubber mallets with interchangeable heads are ideal for use on aluminium and may be used in the manufacture of panels in sheet steel. Copper/rawhide mallets are double ended and ideal for bodyshop use.

DOLLIES - CHOOSING AND USING



Utility Dolly - placed in a damaged flange using the edge most suitable to the size and shape of the original.



Dome Dolly - used for re-shaping crowned panels, but its choice will depend on the shape of the original crown.



Thin Toe Dolly - toe dollies have a low crown and are most suitable for re-shaping. The dolly can be used in the hand to deliver a series of blows to the underside of the panel. This action releases any stresses locked in this area of metal.



Curved Dolly with Handle - handle provides extra reach for large curved surface, plus small surface on handle end for small area repair work.



Grid Dolly - this is a special dolly for shrinking work. It has a large crowned grid face on the surface and a plain flat face on the base for normal finishing. This dolly, combined with the shrinking beater and the application of heat, provides quick and effective shrinking.



Curved Dolly - used for raising a low spot on a panel. The edge can also be used to restore the shape of a roof.



BODY



Spoons - spoons are used for bumping and prying, they can also be used instead of a dolly when direct access to the rear of a panel is obstructed. The choice of spoon depends on the original contour of the metal, the amount of access available and the proposed action (ie roughing or levelling).



Bumping Tools - these are used for slapping out dents, with or without the backing support of a dolly. (For slight dents or a wavy surface, a dolly is not required). They should only be used where damage is moderate or slight, they are not intended to take the role of the spoon or beater and dolly.

BODY REPAIR TOOLS

PANEL BEATING HAMMERS

- High quality forged alloy steel heads with hardened striking surfaces
- Octagonal hickory shafts, secured with unique double-wedge system – wood and steel
- Selection of faces available, in both round and square formats:

Flat Face

Crowned Face

Shrinking Face

- For ease of identification, coloured rings are fitted to the hammer shafts to denote flat or crowned faces

Blue Flat Face

Red Crowned Face

Black Shrinking Face







Spares: 056020 Replacement Shaft and Wedge Kit

Panel Beating Hammers Range and Specifications

Part No.		Hammer Type	Face Type	Face (1) mm	Face (2) mm	Weight kg
056000		Standard Beating	Flat	Round – 41	Square – 38	0.425
056100		Standard Beating	Crowned	Round – 40	Square – 38	0.46
056800		Light Beating	Flat	Round – 30	Square – 28	0.40
056200		Light Beating	Crowned	Round – 30	Square – 28	0.368
052900		Pein & Finish	Flat	Round – 40	Straight pein	0.425
056500		Pein & Finish	Crowned	Round – 40	Straight pein	0.425

Panel Beating Hammers Range and Specifications cont.

Part No.		Hammer Type	Face Type	Face (1) mm	Face (2) mm	Weight kg
053000		Pick & Finish	Flat	Round – 39	Pick	0.430
056600		Pick & Finish	Crowned	Round – 40	Pick	0.42
056900		Shrinking	Flat & Shrinking	Round – 41	Square – 38	0.46
052800		Shrinking	Shrinking	Round – 41	Square – 38	0.425
053700		Curved Pein	Crowned	Round – 40	Curved Pein	0.425

MALLETS

053100

Rubber Faced Mallet

- Flat and cone shaped inter-changeable heads
- Ideal for use on aluminium and light gauge steel
- Replacement heads available:
 053111 Cone Shaped Head
 053112 Flat Shaped Head



053200

Copper / Rawhide Mallet

- Double-ended mallet, ideal for bodyshop use
- 1.1 kg weight



BODY REPAIR TOOLS

DOLLIES

- A range of high quality craftsman’s dollies for shaping and forming body panels
- Drop forged from alloy carbon steel, hand ground and polished

Dolly Range and Specifications

Part No.		Description
054301		Thin Curved Dolly Length: 132mm Width: 59mm Depth: 41mm Weight: 1.14kg
054601		Pinch Wedge Dolly Length: 111mm Width: 65mm Depth: 26mm Weight: 0.82kg
054801		Thin Toe Dolly Length: 118mm Width: 55mm Depth: 25mm Weight: 0.94kg
054901		Anvil Dolly Length: 102mm Width: 73mm Depth: 62mm Weight: 1.44kg
055001		Grid Toe Dolly Length: 120mm Width: 59mm Depth: 31mm Weight: 1.30kg
055201		Utility Dolly Length: 70mm Width: 70mm Depth: 64mm Weight: 1.26kg

Part No.		Description
055401		Heel Dolly Length: 80mm Width: 61mm Depth: 30mm Weight: 0.90kg
055501		Hatchet Dolly Length: 124mm Width: 54mm Depth: 29mm Weight: 0.74kg
055601		Curved Head Dolly Length: 128mm Width: 91mm Depth: 69mm Weight: 1.42kg
055701		Dome Dolly Length: 56mm Width: 56mm Depth: 56mm Weight: 0.73kg
055801		Heavy Toe Dolly Length: 121mm Width: 59mm Depth: 30mm Weight: 1.30kg

BODY REPAIR TOOLS

BUMPING SPOONS

- A selection of bumping spoons for roughing and/or prying in the preparation of body panels
- Can also be used in place of a dolly where access is restricted

Bumping Spoons Range and Specifications

Part No.		Description	Length mm	Width mm	Weight kg
051201		Heavy Duty Pry Spoon	390	58	1.30
057300		Pry & Surfacing Spoon	290	52	0.76
057400		General Purpose Spoon	295	38	1.16
057800		Angled Surfacing Spoon	195	45	1.60

BODY

BUMPING TOOLS

- Curved serrated steel blades, ideal for flattening bumps and dents and for semi-finishing work on body panels
- Great for aluminium panels, thin steel or fine adjustment work, can be used for bumping, slapping or filling
- Milled serrated teeth help prevent metal stretch

Bumping Tools Range and Specifications

Part No.		Description	Length mm	Width mm	Weight kg
059400		Flat Blade	350	35	0.72
059500		Half Round	350	33	0.68
059700		Flat Blade Fine Cut	488	35	0.64
059800		Flat Blade Medium Cut	488	35	0.64

BODY REPAIR TOOLS

TOOL SETS

Contents

Part No.	Description	Kit Part No.				
		058103	058201	058001	058301	058401
	Number of tools	7	6	11	14	19
052800	Panel Beater - Shrinking Flat Face			•	•	•
052900	Panel Beater - Straight Pein Flat Face					•
053000	Panel Beater - Pick And Flat Face					•
053700	Panel Beater - Curved Pein Crowned					•
056000	Panel Beater - Standard Flat Face	•		•		•
056100	Panel Beater - Standard Crowned Face					•
056200	Panel Beater - Light Crowned Face		•		•	•
056500	Panel Beater - Straight Pein Crowned	•		•	•	
056600	Panel Beater - Pick And Crowned				•	
053100	Rubber Faced Mallet		•		•	•
054301	Thin Curved Dolly	•	•	•	•	•
054801	Thin Toe Dolly		•			
054901	Anvil Dolly		•			
055001	Grid Toe Dolly			•	•	•
055201	Utility Dolly	•		•	•	•
055401	Heel Dolly	•		•	•	
055701	Round Head Dolly					•
055801	Heavy Toe Dolly	•		•	•	•
051201	Heavy Duty Pry Spoon					•
057300	Pry / Surfacing Spoon	•		•	•	•
057400	General Purpose Spoon			•	•	•
057800	Angled Surface Spoon				•	•
059400	Bumping Blade Tool Flat		•			•
059600	Door Lock Hole Reforming Tool					
057100	Adjustable File Blade Holder with 9TPI Body Blade			•	•	•

058103

Body Repair Set – Starter Kit

- General purpose starter kit
- Contains 7 tools
- See left for kit contents



058201

Body Repair Set – Lightweight Kit

- Lightweight kit suitable for working on aluminium and light gauge steel
- Supplied in lockable metal case
- Contains 6 tools
- See left for kit contents



BODY REPAIR TOOLS

058001

Body Repair Set – Standard Kit

- Basic general purpose set of bodyshop tools
- Supplied in lockable metal case
- Contains 11 tools
- See page 74 for kit contents



058301

Body Repair Set – General Kit

- Comprehensive general purpose set of bodyshop tools
- Supplied in lockable metal case
- Contains 14 tools
- See page 74 for kit contents



058401

Body Repair Set – Master Kit

- Master set of panel beating tools
- Supplied in lockable metal case
- Contains 19 tools
- See page 74 for kit contents



BODY

BODY REPAIR TOOLS

PANEL PULLING

052700

Panel Puller – Heavy Duty

- Slide hammer panel puller with steel hammer slide (1.6kg)
- Replacement screws available for attaching to panels part no. **052712**



BODY BLADES

057100

Adjustable Body Blade Holder Complete with 9TPI Blade (057111)

- Adjustable blade holder, suitable for forming and shaping fillers and metal during body repair work
- Made from aluminium with steel adjuster and base plate
- Range of blades available in single blades and boxes of 10
- Adjustable Body Blade Holder (without blade) part no. **057101**

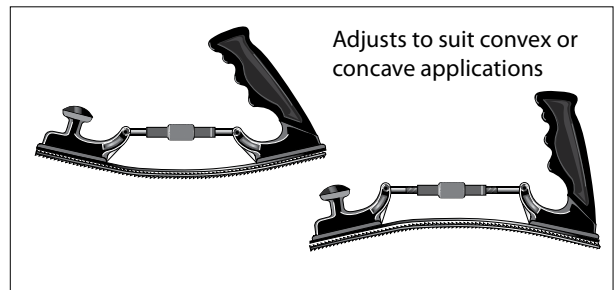

Body Blades

- Suit **057101** Body Blade Holder
- Heat treated and precision sharpened for easier cutting and extended life
- Each precision tooth is cut individually for accuracy and long life
- Edges of blade are chamfered to avoid damage to the vehicle body
- Available in single blades and boxes of 10

Specifications

Part No. Single	Part No. Box of 10	Description	TPI	Length mm
057111	057121	Standard Flat Cut	9	356
057112	057122	Fine Flat Cut	13	356
057115	057125	Plasticut Flat	6.5	356



HOLE CUTTERS

040011

Zipcut Spot Weld Remover

- Adjustable, auto-centring tool for removal of spot welds
- 5/16" hex shank for use with drill chucks of 3/8" capacity
- Replaceable cutters and pins available:
 - 040014 Spare Cutters
 - 040015 Spare Pins (3)

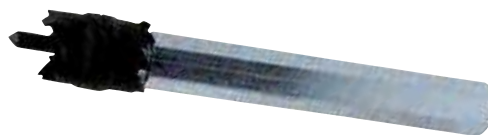

Spot Weld Drills

- High speed cobalt steel drills, for removal of spot welds without distortion

Part No.	Description	Qty	Length mm	Drill Dia. mm
040201	Stubby	1	80	8
040213	Stubby	1	70	6.5



040213

CryoCobalt™ Drill

- CryoCobalt™ Drills are specially designed for drilling very hard metals
- Ideal for drilling high strength alloy steels, ultra high strength boron steels, as well as aluminium chassis, panels and rivets
- Added cobalt increases micro-sharpness and operating temperatures
- Cryophase process improves flexibility and extends bit operating life
- CryoCobalt™ drills can be re-sharpened
- Material: CM-88™ chrome moly cobalt high heat steel
- Heat resistance: up to 1200°F / 650°C
- Hardness: 66-68Re
- Coating: gold oxide
- Cryophase: patented thermal cycling cryogenic treatment

Part No.	Description	Qty	Length mm	Drill Dia. mm
040265	135° Split Point	1	105	6.5
040280	135° Split Point	1	115	8



040265

040280

Multi-Cut Hole Cutter

- Self-centring conical hole cutter for metal, fibreglass and plastics up to 3mm thick

Part No.	Capacity mm	Steps mm	Shank Dia.
040900	11 - 29	1.6	3/8"



043000

Panel Hole Punch – 6mm

- Specialist tool for punching 6mm diameter holes in panels and flanges
- Shaped head to fit over gutters, wheel arches, etc



BODY

SHEET METAL TOOLS

CUTTING AND FOLDING

Lightweight Sheet Metal Cutters - Bench Mounted

- Reversible ratchet action roller cutters for straight, curved and angle cutting on mild sheet steel
- Includes safety shear pin to prevent damage from overloading
- Supplied with bench mounting bracket

Part No.	Description	Capacity mm	Replacement Cutter Wheel	Optional
042000	Lightweight	1.6	042002	Vice Mounting Block part no. 042001
042100	Heavy Duty	3.2	042102	—



042200

Sheet Metal Folder, Bench Model – 600mm width

- Produce up to 100° folds, for fabrication of box and channel sections
- Spring assisted clamping blades for ease of operation
- Vice mounted folder for mild steel up to 1.2mm thick and 610mm wide
- Supplied with protractor for accurate fold angles



FLANGING AND CRIMPING

'Rolastep' Flanging Tools (Jogglers)

- Lightweight portable tool recommended for adhesive panel bonding
- For producing a continuous stepped flange (**042300**: 17mm and **042400**: 12mm wide)
- Twin drive rollers can be adjusted for metal thickness to avoid distortion
- Simple to use with spanner, socket etc. to produce continuous stepped lap joint
- For use on sheet metal up to 1.2mm thick
- **042400** produces a continuous 12mm lap joint



Part No.	Dimensions mm	Step Width mm	Step Depth mm	Min. Internal Radius mm	Min. Radius Over Corrugation mm	Sheet Metal Thickness mm	Capacity swg	Drive Nut Size mm	Weight kg	Replacement Drive, Gear, Screw and Bush	Conversion
042300	290 x 60 x 70	17	1	33	12	0.5 to 1.2	24 to 18	17	1.15	042401	042403
042400	290 x 60 x 70	12	1	33	12	0.5 to 1.2	24 to 18	17	1.00	042401	042402

042500

Hand Edge Setter / Flanging Tool

- Hand operated tool, to produce a stepped edge on sheet metal up to 1.2mm thick
- 20mm wide jaw on specially designed head, produces stepped lap joints quickly with minimum effort



043100

Door Skin Crimping Tool

- Hand held tool for crimping and bending flanges when replacing door skins and panels
- Replaceable nylon pads prevent damage to doors when crimping
- Replacement pads available:
 - 043101** Replacement Pad 32mm wide
 - 043102** Replacement Pad 50mm wide



SELF GRIP PLIERS

WELDING CLAMPS

065008

Sheet Metal Clamp

- Wide jaw locking clamp for holding sheet steel and body panels
- Jaw width – 75mm



065012

Deep Throat Welding Clamp

- Split jaw locking clamp, gives maximum access to working area
- Jaw width – 75mm



065011

'C' Clamp

- Large capacity deep throat clamp with small gripping area for awkward shapes and access
- Jaw opening width – 90mm. Jaws closed width up to 150mm. Depth 55mm



065014

'C' Clamp

- Extra large capacity deep throat clamp
- Jaw opening width – 300mm. Jaws closed width up to 405mm. Depth 250mm



065050

Spot Weld Plier

- For use as a standard welding clamp while MIG spot welding
- Product eliminates 'burn through' on thin panel work
- Features a copper alloy clamp pad with a low affinity for molten weld – this does not allow the weld to adhere and prevents burn through
- Steel with copper alloy pad
- Supplied in wallet
- Body repair shops, industry, sheet metal works etc



SELF GRIP PLIERS

065035

Micro Welding Clamp Set - 2 piece

- Compact lightweight aluminium clamps, quick and easy to use
- Length – 100mm
- Capacity – 20mm



065020

Axial Grip Welding Clamp 'L'

- Thin jaw flat axial grip clamp
- Jaw width – 18mm
- Jaw capacity – 18mm



BODY

065025

Axial Grip Welding Clamp 'J'

- Restricted access axial grip clamp
- Jaw width – 18mm
- Jaw capacity – 18mm



065030

Axial Grip Welding Clamp 'W'

- Wide jaw flat axial grip clamp
- Jaw width – 56mm
- Jaw capacity – 18mm



SELF GRIP PLIERS

GRIP WRENCHES

066000

Grip Wrench Set- 5 piece

- A combination of five different popular grip wrench locking pliers presented in a practical plastic storage wallet
- An ideal set for both automotive and industrial technicians and engineers

Contents

Part No.	Description	Length (mm)	Capacity (mm)	Weight (g)
066001	5" Curved Jaw	135	0-30	180
066003	10" Curved Jaw	235	0-63	600
066008	7" Omnium Grip	200	0-40	410
066009	10" Omnium Grip	235	0-60	630
066012	10" Pinch-Off Clamp	235	30	380



066001

Curved Jaw Grip Wrench 5"

- General purpose grip wrench for a wide variety of applications
- Narrow profile, large opening curved shaped jaws
- Provides firm grip on all round shapes
- Length 135mm, capacity 0-30mm, weight 180g



066003

Curved Jaw Grip Wrench 10"

- General purpose grip wrench for a wide variety of applications
- Narrow profile, large opening curved shaped jaws
- Provides firm grip on all round shapes
- Length 235mm, capacity 0-63mm, weight 600g



066008

Omnium Grip Wrench 7"

- Modern, multipurpose design ideal for all trades, including welding, automotive, plumbing, DIY etc
- Unique jaw configuration combining straight, curved and convex profiles
- Versatile tool which securely grips round, flat and larger sized objects
- Length 200mm, capacity 0-40mm, weight 410g



066009

Omnium Grip Wrench 10"

- Modern, multipurpose design ideal for all trades, including welding, automotive, plumbing, DIY etc
- Unique jaw configuration combining straight, curved and convex profiles
- Versatile tool which securely grips round, flat and larger sized objects
- Length 235mm, capacity 0-60mm, weight 630g



066012

Hose Pinch-Off Clamp

- Instant clamping of hoses without risk of damage to the hose
- Ideal for brake, fuel, cooling system hoses
- Also suitable for small diameter pipe (up to 30mm)
- Length 235mm, capacity 30mm, weight 380g



RADIO REMOVAL

036900

Radio Removal Kit

- 20 piece set of radio removal tools in wallet
- These key like tools are used to remove the radio from a whole range of vehicles
- A combination of flat steel and round steel keys designed for specific models of radio
- Radio manufacturers covered: Blaupunkt, Clarion, Becker, Alpine, Grundig VDO, JVC, Pioneer
- For the following makes of vehicle: Citroen, Peugeot, Skoda, BMW, Opel, VW, Mercedes-Benz, Porsche, Audi, Alfa, Fiat, Ford & Renault



BODY TRIM

045800

Universal Body Trim Tool

- Multi-application tool, for use on all types of trim and trim clips
- Suitable for weather strips, door trim, plastic mouldings, motifs, badges, clips, etc



046000

Trim Clip Remover and Plier

- For quick removal of clips and fasteners
- Allows trim panels to be un-hooked without risk of breaking or tearing



045500

Automotive Trim Removal Tools

Designed to enable the safe, undamaged removal of vehicle trim panels

- A must have for anyone needing to remove and re-fit interior and exterior trims
- The plastic construction means the likelihood of damaging the trim or metal panel is vastly reduced
- Ideal for roof linings, door trims, panel trims, door cards, air bag trims and door or body rubbing strips
- A set of five angled lever and panel pullers manufactured in strong yet flexible plastic which allows a reasonable force to be applied without damage



BODY

GENERAL BODY TOOLS

DOOR HINGE

045400

Hinge Pin Remover – Hollow Pins

- 12mm square bar, with 5.5mm jaw opening
- Supplied with a set of three roll pin removers

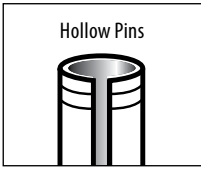

Remover Style	Part No.	Suits
Roll Pin Removers	045404	3.5mm pins
	045405	4.5mm pins
	045406	5.5mm pins
	045403	Set of all three



040101

Impact Driver Set

- For use with a medium weight hammer to loosen stubborn screws and nuts
- Ideal for removal of brake drum screws and door hinge brackets
- Supplied with a range of interchangeable bits

Contents

Part No.	Description	Size	Length (mm)
670650	Slotted Blade	5/16"	36
670652	Slotted Blade	3/8"	36
670654	Slotted Blade	1/2"	36
670660	X Point	No. 1	36
670662	X Point	No. 2	36
670664	X Point	No. 3	36
670666	X Point	No. 4	36
670512	Hex Bit	5mm	36
670514	Hex Bit	6mm	36
670518	Hex Bit	10mm	36
670596	Torx Bit	T30	36
670598	Torx Bit	T40	36
670600	Torx Bit	T45	36
670602	Torx Bit	T50	36



059200

Corrosion Assessment Tool

- Designed by British Inspectorate, to assess acceptable safe level of corrosion for vehicle roadworthiness
- Combination tapping hammer, blunt scraper and short lever in the one tool



051600

Protective Car Seat Cover

- Seat protection
- 100% nylon seat cover to protect vehicle seats from soiling/damage during repair or maintenance work





WORKSHOP

 Sykes-Pickavant®

ELECTRICAL TESTING

014900

Circuit Tester 6, 12, 24 Volt

- High quality, professional circuit tester suitable for 6, 12 and 24 volt circuitry
- Features highly durable polycarbonate handle and hardened steel probe to ensure long service life
- Alligator clip and 1.5 metre lead is insulated by heavy duty rubber with a metallic spring at the handle's base providing additional protection and support to the lead
- Fitted with standard automotive bulb for easy replacement



300424

Cordless Circuit Tester

- Professional cordless circuit tester suitable for testing DC circuits from 3V to 28V
- Safe to use on engine management systems - e.g. ECM's, sensors, transducers etc
- Three-way voltage indication - illuminates LED, buzzes and vibrates on contact with live wire
- Solid state lamp for longer lasting performance
- Unique v-groove needle accessory for wire piercing
- No ground wire or clips required
- Supplied with long-life alkaline batteries



300426

Inteliprobe 6-24 Volt Tester

The Inteliprobe is an intelligent circuit and continuity tester ideal for locating bad earths, breaks in continuity and short circuits. Simply hook up the battery clips to the vehicle battery and the tool is ready for use. Suitable for 6V – 24V electrical systems, which makes it ideal for motorcycles, cars, boats and trucks.

- **Polarity Test** - LED changes colour to indicate the polarity on the probe pin
Red = positive, Green = negative
- **Continuity Test** - between the probe pin and the croc clip on the end of the green lead. LED shows green for a continuous (or closed) circuit
- **Short Circuit Protection** - a thermal breaker which can be manually reset, will trip out at 8 Amps providing protection to the vehicle's wiring system
- **On-vehicle Component Tests** - pushing the switch forward causes a positive potential on the probe tip, and pushing the switch backwards causes a negative potential on the probe tip. This enables the user to energise components such as lights, locks, and trailer connections without having to remove them from the vehicle
- **Off-vehicle Component Tests**- by using the green lead as ground connection, energising the probe tip will enable the user to check the component



300420

Electrical Fault Finder

Specially designed tool for tracking and tracing short and open circuits, broken wires and current leaks on any electrical circuit with voltages from 6 to 42 volt DC. The wide working voltage range, automatic short/open detection, adjustable sensitivity levels and flexible antenna probe enables the technician to troubleshoot a complete array of common electrical problems without having to untie wire harnesses or remove body panels.

- Suitable on all kinds of circuits with voltages between 6 and 42 volt DC, such as those found in cars, HGV's, buses, trailers, tractors, boats, etc.
- Features automatic open/short circuit detection and adjustable sensitivity
- 42V ready for use in the new generation of vehicles with mixed or single 42 volt systems
- Operates on DC voltages from 6 to 42 volts
- Internally protected against power surges and overloads
- 200mm (8") flexible probe allows reaching wires in congested places
- Transmitter and receiver LED show open or short circuit conditions
- Variable audio/visual signal provides fast and intuitive feedback on the circuit/wire proximity
- Kit includes **300424** Cordless Circuit Tester
- Supplied with user manual in protective carry case

**Contents**

Part No.	Description
300421	Transmitter
300422	Receiver
300424	Cordless Circuit Tester
300425	Fuse Block Connector Set

300425

Fuse Block Connector Set

- Allows access to the vehicle electrical circuits, via the fuse socket
- Can be used with standard multimeter probes or clips etc to check voltage, current, circuits and components
- Three sizes to fit in place of the relevant circuit's fuse
- Provides easy access to circuits to energise or check electrical components and accessories

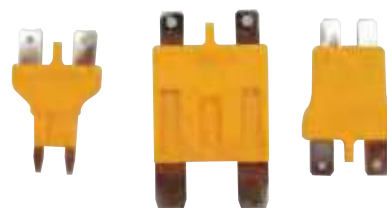

032005

Battery Acid Hydrometer

- Professional tester for measuring the state of charge in lead acid batteries
- Measures specific gravity of battery acid and indicates battery condition with a red / green scale
- Accurate, simple to use with glass tube and float, rubber siphon and probe



ELECTRICAL TESTING

300500

Automotive Digital Multimeter

This multimeter is an invaluable tool for performing general auto electric tasks and troubleshooting problems with ignition, fuel injection and body electrics. The small and ergonomic profile makes handling and operation easy and convenient. It is supplied with quality test leads, temperature probe and alligator clips in a handy carry case. Enables measurement of engine RPM, ignition dwell angle and temperature in addition to performing electrical checks such as voltage drop, continuity and resistance:

- Full control manual range selection
- Large 3½ digit LCD display
- AC/DC voltage measurement up to 600 volt
- DC current measurement up to 10 A
- Tachometer function measures from 500 to 10,000 rpm
- Dwell measurement from 0 to 120°
- Temperature measurement from -40°C to 1000°C
- Resistance measurement up to 2 MΩ
- Diode and continuity tests
- Overload protection and auto power-off
- Soft holster for instrument protection
- Data hold facility for 'freezing' of readings
- Supplied with test leads, croc clips and instructions



Technical Specifications

Display	- 3 ½ Digit LCD (Max reading 1999) - ½" (12.5mm) Digits - High Voltage warning indicator - Automatic (-) negative polarity indicator - Automatic Zeroing - Automatic over-range indication - Low battery indicator
Power Source	Standard 9 volt alkaline battery type NEDA 1604 IEC 6F 22 (included)
Test Probes	One red and one black 1000V/10A rated (IEC1010/EN61010 CAT II), 35" long, K-type temperature probe
Physical Dimensions (including holster)	5.51" (H) x 2.75" (W) x 1.41" (D) 140mm (H) x 70mm (W) x 36mm (D)
Weight	Approximately 12.34 Oz (350g) including battery

Electrical Specifications

DC Voltage	± 0.25% ± 2dgts, 1M Ohm input impedance, 600V AC/DC Overload protection
AC Voltage	± 1.5% ± 5 dgts, 450K Ohm input impedance 40 to 200 Hz, 600V AC/DC Overload protection
DC Current	± 1.0% ± 3 dgts, Internal 10A/250V fuse protection
Resistance	± 1.0% ± 3 dgts, 250V AC/DC Overload protection
Tachometer	30 to 20000 rpm ± 2 rpm
Diode Test	2.4 ± 0.6 mA test current, 3.2V max test voltage
Continuity Test	Audible indicator (Buzzer) with circuit resistance below 100 Ohm
Temperature	40° to 400°C (± 0.7 + 3 dgts), 400°C to 1000°C (± 1.5 + 10 dgts)

300535

Auto Ranging Automotive Digital Multimeter

This professional automotive multimeter provides many additional functions over the standard unit and is an essential tool for the auto electrician or auto technician to assist with electrical system diagnosis and troubleshooting. It enables common test functions such as blink type fault code detection, DTC decoding and dynamic O2 sensor testing amongst many others. The small and ergonomic profile and single function select knob makes handling and operation easy and convenient.

- Fully auto ranging, primary and secondary display, bar graph, overload protection and auto power-off
- Large selectable 4 ¾ or 3 ¾ digit main display – 4 digits secondary display
- 42 segments analogue bar graph
- DC voltage measurement up to 1000 volt
- AC voltage measurement up to 750 volt
- AC/DC current measurement up to 10A
- Tachometer function with inductive pick up measures from 30 - 20,000 rpm
- Dwell measurement in degrees from 0 - 360° or duty cycle from 0-100%
- Temperature measurement from -20°C to 1000°C or 0° to 1832°F (selectable °C or °F)
- Resistance measurement up to 40 MΩ
- Frequency measurement from 10 to 20 KHz
- Fuel injection test measures pulse width from 0.05 to 250mS, or duty cycle from 0 to 100%
- Oxygen sensor test function
- Alternator test function
- Fault code reader & DTC decoder
- Diode and continuity tests
- Overload protection and auto power-off
- Soft holster for instrument protections



WORKSHOP

Technical Specifications

Display	- 4 ¾ digits main display - 4 digits secondary display - 42 segments analog bargraph (20 updates/second) - Backlight - Automatic (-) negative polarity indicator - Automatic zeroing - Automatic over-range indication - Low battery indicator
Power Source	One standard 9 volt alkaline battery type NEDA 1604 IEC 6F 22 (included)
Test Probes	One red and one black, 1000V/10A rated (IEC1010/EN61010 CAT II), 35" long
Temperature Probe	Bead type K thermocouple
Tachometer Function	Inductive pickup
Physical Dimensions (including holster)	6.30" (H) x 3.22" (W) x 1.89" (D) 160mm x 82mm x 48mm
Weight	Approximately 12.14 Oz (345g) including battery

Electrical Specifications

DC Voltage	0 to ± 1000V, ± 0.3% ± 2dgts, 10M input impedance
AC Voltage	0 to 750V, ± 2.5% ± 5 dgts, 10M input impedance 50 to 500 Hz
DC Current	0 to ± 10A ± 0.8% ± 4 dgts
AC Current	0 to 10A, ± 0.8% ± 4 dgts
Resistance	0 to 40M ± 0.8% ± 5 dgts
Frequency	0 to 20 KHz ± 0.01% ± 2 dgts
Tachometer	30 to 20,000 rpm ± 2 rpm
Dwell	0 to 360° ± 1.2°/krpm/cyl + 2d
Fuel Injector (pulse width)	0.05 to 250 mS ± 0.05 mS ± 1d
Temperature	-20° to 1000°C or 0°F to 1832°F (± 2% + 1 dgts)

ELECTRICAL TESTING

Features

- Large easy to read 0.393" (10mm) digit display
- Single knob selects functions
- Peak hold function
- Display data hold
- Rugged plastic enclosure
- Design allows comfortable handling
- One rotary switch operation
- Resistance measurement
- 2 readings per second sampling
- Continuity check with audible indicator
- Protective hand guard
- 50 hrs in use battery life
- Soft carrying deluxe pouch
- Test leads and batteries included

Applications

- Measure currents in circuits like battery chargers, alternators, starter motors, electrical loads etc
- Check grounds, voltage drops and continuity across connectors, wires, cables, relay, contacts, lamps, switches, etc
- Check components like alternators, diodes, relays, coils, condensers, ignition coils, magnetic pick-ups, motors, switches, fuses etc
- An essential all round troubleshooting tool for electrical and electronic circuits and systems

Technical Specifications

- **Display**
 - Large 4 digit LCD (max. reading 9999)
 - Automatic over-range indication
 - Auto power off
 - 0.393" (10 mm) digits
 - Units indicator
 - Relative measure indicator
 - Peak hold indicator
 - VDC/VAC indicator
 - Continuity indicator
 - Automatic (-) negative polarity indicator
 - One touch button auto zeroing
 - Low battery indicator
- **Power Source:** Two (2) standard AA
- A 1.5 volt alkaline battery type AAA UM4 or equivalent
- **Test Probes:** One red and one black, 1000V/15A rated (EC1010/EN61010 CAT II), 35" long
- **Physical Dimensions:** 7.95" (H) x 2.62" (W) x 1.33" (D) – 202mm (H) x 67mm (W) x 33.8mm (D)
- **Weight:** Approximately 6.34 oz (180g) including battery

* Please note - features, applications, technical specifications above are common to both products

300400

100 Amp Micro Current Clamp Meter

- Specially designed for measuring very low currents, to accuracy of 0.001 of an amp
- Small jaw: 1.2" (W) x 0.53" (d) (300 x 13.4mm)
- Clamp opens up to ½ inch (12.5mm)
- Relative measurement
- AC/DC voltage measurement up to 600 Volt
- AC/DC current measurement from 0.001amp up to 100 amp

Electrical Specifications

DC Voltage	± 2% ± 2 dgts 600V AC/DC maximum 660 vrms overload protection
AC Voltage	± 1.5% ± 5 dgts 50 to 500 Hz, 600V AC/DC maximum, 660 Vrms overload protection
DC Current	± 2.5% ± 10 dgts, 100 Amp Maximum 150 arms overload protection
AC Current	± 2% ± 10 dgts, 600 Amp Maximum 150 arms overload protection
Resistance	± 1% ± 3 dgts, 100K 660 Vrms overload protection
Continuity Test	Audible Indicator (Buzzer) when circuit resistance is below 1000 max voltage test <3Vdc



300410

1000 Amp Current Clamp Meter

- AC/DC voltage measurement up to 1000 volt
- AC/DC current measurement up to 1000 amps
- Clamp opens up to 1 inch

Electrical Specifications

DC Voltage	± 1% ± 2 dgts 1000V AC/DC maximum 1020 Vrms overload protection
AC Voltage	± 1.5% ± 5 dgts, 50 to 500 Hz, 1000V AC/DC maximum, 1020 Vrms overload protection
DC Current	± 2.5% ± 10 dgts, 1000 amp maximum, 1020 arms overload protection
AC Current	± 2% ± 10 dgts, 1000 amp maximum, 1020 arms overload protection
Resistance	± 1% ± 3 dgts, 100K maximum, 660 Vrms overload protection
Continuity Test	Audible indicator (buzzer) when circuit resistance is below 1000 max voltage test <3 Vdc



300430

Infra-Red Laser Tachometer

- Non-contact Infra-Red Laser Tachometer for measuring RPM on rotating shafts, pulleys, wheels etc.
- Infra-red laser picks up signal from reflective tape which is placed on the rotating shaft
- Features bright and powerful laser optical system for easy targeting of rotating object, even in bright daylight
- Measurements can be obtained from safe and comfortable distances from 5 to 50cm
- The large 5 digits display allows measurements without the need to switch scales or multiply reading ranges
- Unit comes complete with batteries and reflective tape in a soft carrying pouch



Specifications

RPM Range	2.5 to 99,999
Accuracy	Within 0.1 RPM
Memory	Max, Min, Last value
TOT	Total Revolution Count
Display	5 Digit LCD
Distance	50 – 500mm
Resolution	0.1 rpm < 1000 rpm 1.0 rpm >1000 rpm

300440

Infrared Thermometer

- High precision non-contact thermometer
- Features a unique dual laser beam system which accurately pinpoints the targeted area, ensuring optimum distance from the object for precise temperature measurement
- Ideal for automotive or industrial applications such as air conditioning and heating systems, cooling systems, and exhaust systems
- Automatic data hold and display resolution
- High and low temperature alarm setting



Specifications

Display	- Backlit LCD - Max Temp - Auto hold function
Temp Range	-50° to 550°C
Accuracy	+/- 1.5% at 550°C

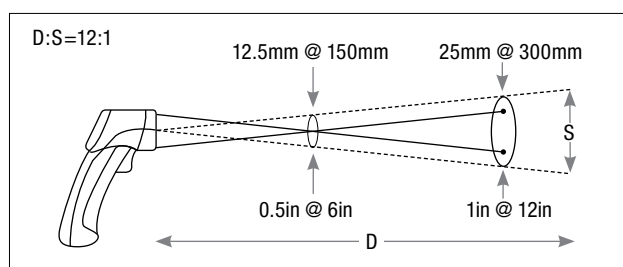

INSPECTION

323700

Sonoscope

- A sensitive sound detector with a built-in diaphragm which amplifies noise to assist in the diagnosis of vehicle concerns such as noisy water pumps, wheel bearings, and other driven auxiliaries
- Robust metal and plastic construction
- Hose Length: 550mm
- Probe Length: 290mm

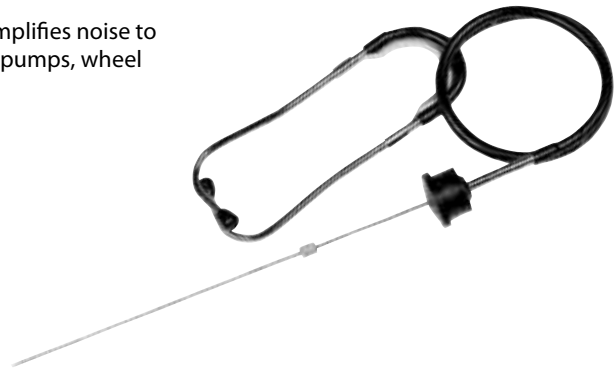

300475

Wireless Electronic Stethoscope – ‘ChassisEar’

Designed for the detection of vehicle noises e.g. rattles, squeaks and air ingress under load, during a road test and for the diagnosis of a wide variety of potential faults e.g. wheel bearings, CV joints, differentials, transmission, injectors, alternators, water pumps, AC compressors and many more.

- Suitable for cars, vans, trucks, buses etc. as there are no cable length issues to overcome
- Pick-up clamps can be attached to many different parts of the vehicle in order to amplify the sounds made under load and in actual driving conditions
- Consists of receiver unit, four transmitter units (4 channels), four pick-up leads, pick-up fixing straps, headphones, batteries, instruction manual & storage case



N.B. Due care and consideration should be taken of driving conditions and regulations when operating the ChassisEAR on the road.

Spare Parts

Part No.	Description	Qty
30047501	Transmitter 1	1
30047502	Transmitter 2	1
30047503	Transmitter 3	1
30047504	Transmitter 4	1
30047506	Pickup Lead and Clamps	4

Thread Restoring Files

- Designed for the restoration of damaged or worn threads
- Suitable for left or right hand threads
- Available in four configurations
- Ideal for where conventional dies cannot be used

Part No.	Thread	Pitch
015600	BSW/BSF	11, 12, 14, 16, 18, 20, 22, 26
015601	SAE/UN	12, 13, 14, 16, 18, 20, 24, 28
015602	Metric	0.75, 1, 1.25, 1.5, 1.75, 2, 2.5, 3
015603	BSP	11, 12, 14, 16, 19, 20, 22, 28



660935

Wire Brush

- Used to clean corroded material and debris from metal components
- Ideal for cleaning damaged or corroded threads
- Hardened and tempered steel wire bristles
- Oil resistant wooded handle



660990

Spiral Screw/Stud Extractor Set (Easy-outs)

- Spiral type five piece set designed to remove broken studs, screws and bolts
- Simply drill a hole in the broken stud or screw to be removed and insert the high strength, left hand thread extractor. Turn anti-clockwise for the tool to bite and unwind the stud
- Suitable for studs, screws and bolts 3-19mm in diameter



018000

Fluted Screw/Stud Extractor & Drill Set

- Fluted type set designed to remove broken studs, screws and bolts
- Includes 5 drills, 10 guides and 5 fluted extractor assemblies for simple and effective removal
- Suitable for all studs, screws and bolts 6-12mm in diameter
- Also available without drills in a simplified kit for customers who already have a drill set – **018200** Fluted Extractor Set



018200



018000

STUD AND NUT

012000

Stud Setters and Extractors

- Compact yet powerful stud extractor used to remove rusted, threaded or seized studs and set new ones
- High strength, eccentric knurled wheel design provides increasing grip and force to affected stud ensuring superior grip with minimal effort
- Stud capacity: 6 – 19mm
- 1/2" square drive



661950

Concentric Roller Stud Extractor Set

- Concentric roller type four piece socket set for extracting damaged, seized, threaded or rusted studs
- High strength cam roller design manufacture from chrome vanadium for durability and long life
- Supplied in blow moulded protective case
- Sizes: 6, 8, 10 and 12mm
- 1/2" square drive



Hydraulic Nut Splitters

- Designed for the efficient removal of seized or rusted nuts without damage to threads
- Available in small or large configurations, supplied singly or as a combined set

Part No.	Description	Max. Nut Size (mm)	Spare Parts
031600	Hydraulic Nut Splitter - Small	22	031612 Cutter & Anvil
033600	Hydraulic Nut Splitter - Large	37	033612 Cutter & Anvil
033604	Hydraulic Nut Splitter – Set (2)	22, 37	–



027600

Air Blow Gun

- Used for cleaning carburettor jets, fuel lines, brake pipes etc, the gun has an infinitely variable air flow with fingertip control and is also suitable for dispensing of some low viscosity fluids
- High velocity 100mm nozzle, cranked for easy access
- High impact resistant body
- Body threaded 1/4" BSP to accept a quick coupler if required



076101

Brake Disc Run Out Set (Magnetic Base & DTI Gauge)

- Used for measuring disc run-out
- Powerful magnetic clamp with on/off lever for easy removal from surfaces
- Flat and 'V' shaped base can be used on both flat and round surfaces
- Simple and accessible fine adjuster for easy and precise settings



Contents

Part No.	Description
077120	High Quality DTI Gauge with Floating Scale
076100	Universal Magnetic Clamp For DTI With Fine Adjustment

028300

Circlip Tool Set

- Uniquely designed T-handle circlip remover used to remove and replace circlip rings on pistons, gears and transmission components
- Enables internal and external operation with the threaded adjusting screw providing precise adjustment without the need to maintain hand pressure like most standard circlip pliers
- Includes four sets of interchangeable tips
- Jaw capacity: 44 – 178mm



660887

Hook, Pick and Scraper Set - 9 piece

- Hardened chrome vanadium steel
- Ergonomic soft grip handles
- Includes multi-purpose scraper, ideal for gasket scraping
- Contains eight hooks and picks, ideal for the fitting and removal of seals, O rings, bushes, springs, cotter pins and fuses



660650

Hydraulic Hose Clamp

- Clamps brake and fuel hoses to allow brake/clutch slave cylinders to be disconnected or removed with minimum fluid loss



GENERAL

040101

Impact Driver Set

- For use with a medium weight hammer to loosen stubborn screws and nuts
- Ideal for removal of brake drum screws and door hinge brackets
- Supplied with a range of interchangeable bits
- Refer to page 51 for kit contents



066000

Grip Wrench Set - 5 piece

- A combination of five different popular grip wrench locking pliers presented in a practical plastic storage wallet
- An ideal set for both automotive and industrial technicians and engineers
- Refer to page 82 for details



Contents

Part No.	Description	Length (mm)	Capacity (mm)	Weight (g)
066001	5" Curved Jaw	135	0-30	180
066003	10" Curved Jaw	235	0-63	600
066008	7" Omnium Grip	200	0-40	410
066009	10" Omnium Grip	235	0-60	630
066012	10" Pinch-Off Clamp	235	30	380

660950

Oil Can

- Fitted with a flexible spout, the oil can operates by force feed and has a spring trigger return
- Allows visible indication of fluid level
- 500ml capacity



670006

Telescopic Pick-up Magnet

- Solid metal construction
- Strong magnetic tip capable of picking up small metallic objects
- Features telescopic shaft to allow extension of 135mm - 490mm and in built pocket clip
- Extension range: 135mm - 490mm
- Holds weights: up to 1.0kg



Flexible Drive Belt Stretcher

- Designed to be a safe, easy and versatile option for flexible drive belt fitment
- Multi-application tools suitable for modern engines featuring stretch drive belts
- Allows the belt to be installed in one operation

Part No.	Description
077400	Flexible Drive Belt Stretcher
077444	Flexible Drive Belt Stretcher – Double Pulleys



077400



077444



TORQUE

 **Sykes-Pickavant®**

WRENCHES

Motorq Professional Torque Wrenches

The 'Motorq' professional range of torque wrenches offer accuracy, comfort and ease of use. The push-through ratchet has been designed for strength with 24 or 30 tooth pattern but with unique engagement design which gives a small rotation angle of 5° or 6°. This type of ratchet provides more precise engagements per revolution and makes left hand torque possible.



- Secure locking mechanism to avoid forced adjustment against the lock
- Extended soft touch handle for comfort and reduced calibration drift
- Fixed-head push-thru ratchet engineered for strength and durability and operates in both clockwise and anti-clockwise directions (ratchet repair kits available)
- Dual scale micrometre style adjustment (Nm/lbf.ft)
- Chemical resistant handle and lens for clear reading of scale
- Accurate to +/- 3% of reading, manufactured to ISO9000:2000 standard
- Supplied with calibration certificate, traceable to national standards
- Supplied in sturdy blow moulded case with hanging slot for protection during storage and transportation



Part No.	Description	Drive	Torque Capacity		Length mm	Weight Kg	Ratchet Repair Kit
		Sq. Dr.	Nm	Lbf. ft.			Part No.
800020	Motorq 20	3/8"	4-20	40-180*	220	0.40	-
800060	Motorq 60	3/8"	8-60	5-45	307	0.80	800116
800100	Motorq 100	3/8"	20-100	15-80	347	0.70	800116
800101	Motorq 101	1/2"	20-100	15-80	347	0.70	800116
800200	Motorq 200	1/2"	40-200	30-150	443	1.00	800306
800300	Motorq 300	1/2"	60-300	45-220	570	1.40	800336
800330	Motorq 330	1/2"	60-330	45-250	683	1.50	800336
800399	Motorq 399	3/4"	80-400	60-300	683	2.10	800396

* Denotes lbf.in.



800805

Motorq Professional Torque Wrench Merchandiser

- Designed as a wall mount or free standing unit to house and display six professional Motorq Torque Wrenches and one Torque Angle Gauge
- Wrenches are held securely by the ratchet heads allowing for easy retrieval
- A convenient storage compartment is located on the rear of the unit to discreetly house the six wrench cases
- Available as panel only for customers who have existing torque wrench stock
- **800806** Merchandiser Panel
- Contents may be customised to suit individual customer requirements (minimum order quantity, please enquire)



Allocated compartments at both the rear & the top to keep cases and calibration certificates safe.



TORQUE

Contents

Part No.	Description	Drive Sq. Dr.	Range Nm	Qty
800020	Motorq 20	3/8"	4-20	1
800060	Motorq 60	3/8"	8-60	1
800100	Motorq 100	3/8"	20-100	1
800200	Motorq 200	1/2"	40-200	1
800300	Motorq 300	1/2"	60-300	1
800330	Motorq 330	1/2"	60-330	1
800700	Torque Angle Gauge	1/2" (M&F)	-	1

WRENCHES

Motorq Heavy Duty Torque Wrenches

The 'Motorq' Heavy Duty range of 'Break Back' action torque wrenches provide an unmistakable signal that can be seen and felt when the set torque is reached. This reduces the possibility of over torquing during noisy and demanding situations in the workshop or at the track.

- Robust construction for heavy duty applications
- Unique 'Break Back' action mechanism gives unparalleled control over the applied torque
- Accurate to +/- 4% of reading, manufactured to ISO9000:2000 standard
- 36 tooth ratchet head with push-thru square drive
- Graduated scale on handle for easy adjustment
- Supplied with calibration certificate, traceable to national standards
- Supplied in sturdy blow moulded case (**800582**) for protection during storage and transportation. Internal handle clips into place for easy carrying



800400

3/4" Dr.

150-700Nm



800500

3/4" Dr.

300-1000Nm



800550

1" Dr.

700-1500Nm



Part No.	Description	Drive	Torque Capacity		Length	Weight	Ratchet Repair Kit
		Sq. Dr.	Nm	Lbf. ft.	mm	Kg	Part No.
800400	Motorq 400	3/4"	150-700	100-500	1150	6.30	800408
800500	Motorq 500	3/4"	300-1000	200-750	1475	7.30	800408
800550	Motorq 550	1"	700-1500	500-1000	1470	10.9	800408

800582

Torque Wrench Storage Case

- Sturdy blow moulded case for protection during storage and transportation
- Internal handle clips into place for easy carrying
- One size fits each of the three Motorq heavy duty torque wrenches



Motorq Torque Angle Gauges

- For turning torqued fasteners such as cylinder head bolts, main and connecting rod bearing bolts and flywheel bolts through a further angle, as per vehicle manufacturer's specifications
- Oil resistant, non-reflective surface and adjustable reaction arm
- Supplied with both male and female square drives



800700

1/2" Dr.

M & F



800750

3/4" Dr.

M & F



800935

Digital Torque Angle Gauge

- For turning torqued fasteners through a further angle, as per vehicle manufacturer's specifications
- Simple to use - calibrate, set angle, mount and use
- Fits on to most ratchets, torque wrenches and power bars via magnetic attachment
- One single tool can be used on 1/4", 3/8", 1/2", 3/4" drives
- Indicates increasing angle on LCD display
- Works in both directions of rotation
- LEDs glow yellow when close to setting and change to green when desired setting is reached
- Audible notice when setting reached
- LEDs glow red when setting exceeded



MULTIPLIERS

Torque Multipliers

Designed to provide higher torque input than would otherwise be possible due to limitations of space or operator strength. The robust design is ideal for extensive use, providing the durability for long service life in tough environments.

- Robust construction means minimal maintenance and long life
- True 5:1, 15.5:1 or 26:1 torque multiplication, accuracy guaranteed better than +/-4%
- High ratios allow the use of a small torque wrench
- Supplied in carrying case with replacement square drive
- Anti wind-up ratchet (anti backlash) fitted to allow safer and more practical operation (**800660 & 800665**)
- Angle protractor for easy torque and angle tightening
- Supplied with two reaction bar styles for maximum versatility



800600
1/2" Input Dr.
3/4" Output Dr.
130-1300Nm



800660
1/2" Input Dr.
1" Output Dr.
300-3000Nm



800655
1/2" Input Dr.
1" Output Dr.
270-2700Nm



800665
1/2" Input Dr.
1" Output Dr.
450-4500Nm

Part No.	Description	Multiplication Ratio	Torque Capacity	Input Drive	Output Drive	Weight
			Nm	Sq. Dr.	Sq. Dr.	Kg
800600	Torque Multiplier 1300	5 : 1	130-1300	1/2"	3/4"	4.3
800655	Torque Multiplier 2700	5 : 1	270-2700	1/2"	1"	4.5
800660	Torque Multiplier 3000	15.5 : 1	300-3000	1/2"	1"	6.1
800665	Torque Multiplier 4500	26 : 1	450-4500	1/2"	1"	7.0

TruCheck Plus

TruCheck Plus includes a comprehensive range of features to ensure the accuracy of precision torque equipment. The innovative design is suitable for click wrenches, dial and electronic wrenches and in 'track' mode will continuously monitor the torque signal.

- Features user 'selectable limit' function. Simply set the target torque and tolerance and TruCheck will calculate whether the reading is within tolerance and indicate the result by illuminating one of three coloured LEDs:
Orange = Low, Green = OK, Red = High
- Fitted with an RS-232 output and includes an RS-232 cable. The reading measurement unit and limit status (Low, OK and High) are output via RS-232
- Three selectable torque units - Nm, lbf.ft. and lbf.in. (always calibrated in Nm)
- Auto reset hold time: two seconds
- Electromagnetic Compatibility (EMC) Directive in conformance with EN 61326:1997
- Includes 27mm hex 3/4" square drive socket (**800433** only)
- Supplied with a traceable calibration certificate

800432

1/2" Sq. Dr.

10-350Nm



800433

27mm Hex Dr.

100-1000Nm



Part No.	Description	Torque Capacity (Nm)	Drive	Weight (shipping)	Display	Torque Units	Accuracy
800432	TruCheck Plus 350	10-350	1/2" Sq Dr	3.2kg	4 Digit, 7 Segment LED	Nm, lbf-ft and lbf-in	+/-1%, +/-1 Digit Over Stated Range
800433	TruCheck Plus 1000	100-1000	27mm Hex (M)*	4.8kg			

* Drive size: 27mm male hex drive supplied with 3/4" square drive socket.

SCREWDRIVERS

TORQUE SCREWDRIVERS

- Sykes-Pickavant torque screwdrivers are precision tools for critical torque setting on automotive components such as sensors, glow plugs, plastic fixtures and TPMS valve cores and valve nuts
- Features micrometre style adjustment (Nm)
- 1/4" square drive for use with 1/4" square drive accessories
- Includes square drive input at end of handle to allow for additional application of torque
- Supplied with 5mm hex key for torque adjustment
- Available in 3.0Nm and 10.0Nm configurations
- Supplied with calibration certificate

800801
1/4" Dr.
0.1-3Nm



800802
1/4" Dr.
2-10Nm



Part No.	Description	Drive	Torque Capacity	Scale Increments	Length	Weight
		Sq. Dr.	Nm	Nm	mm	Kg
800801	Torque Screwdriver 3	1/4"	0.1-3.0	0.1	170	0.45
800802	Torque Screwdriver 10	1/4"	2.0-10.0	0.5	170	0.45

800820 Tyre Pressure Monitoring System (TPMS) Torque Kit

- Ideal tool set to ensure critical torque settings are correct when servicing TPMS systems on modern and premium vehicles
- Contains tools required for servicing and replacing TPMS valve cores and nuts
- Features two Sykes-Pickavant torque screwdrivers with a combined range of 0.1 – 10.0Nm
- Supplied in protective foam tray
- Supplied with calibration certificate

Contents

Part No.	Description	Specifications
800801	Torque Screwdriver	0.1 - 3.0Nm
800802	Torque Screwdriver	2.0 - 10.0Nm
699002	T-Bar Handle (For 800802)	3/8" Sq. Dr.
699009	1/4" Valve Core Tool	-
699010	1/4" Torx Bit	T10
699015	1/4" Deep Socket	11mm
699016	1/4" Deep Socket	12mm
699013	TPMS Grommet Tool	-



Torque Screwdriver		T-Bar Handle	Valve Core Tool	Torx Bit	Deep Socket	
0.1-3.0Nm	2.0-10.0Nm	3/8" sq dr	1/4" sq dr	T10 - 1/4"sq dr	11mm - 1/4" sq dr	12mm - 1/4" sq dr



PULLERS

 Sykes-Pickavant®



Sykes-Pickavant pullers are manufactured to a very high specification and subjected to rigorous testing - far exceeding their stated capacities. The legs and beams are drop forged from high quality steel and then heat treated for extra strength and durability. Pullers are normally classified as either hydraulic or mechanical with many different types within these two styles.

CHOOSING THE RIGHT PULLER FOR THE JOB



Always use a 3 leg puller if possible
This gives a better load distribution and is much safer in use

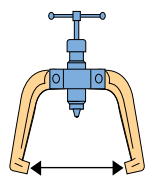

Decide what 'spread' is required. This is determined by the width of the part to be pulled

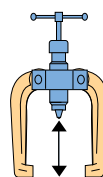

Decide what 'reach' is required. This must be at least equal to or larger than the depth of the part which needs removal

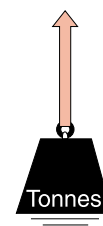

Estimate out what 'force' is required. More force may be required for rusted parts or where there is a large area of surface contact. Hydraulic pullers enable maximum force to be applied with minimum effort.

Alternatively, choose a puller whose force screw diameter is at least half the size of the shaft of the item to be removed. If in doubt, use the next largest - using an undersized puller will slow down the job and lead to frustration

QUICK REFERENCE GUIDE

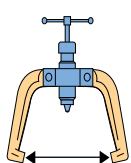

Puller Spread Max mm

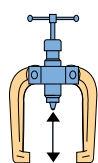

Puller Reach Max mm

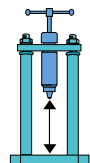

External Reach Max mm



Adaptor Diameter



Leg Style

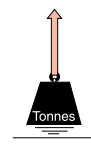

Safe Working Load (tonnes)



Ram Extension mm

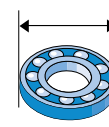

External Spread mm

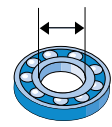

Internal Spread mm

TYPES OF PULLER



Hydraulic Pullers

These have a simple, grease-filled ram instead of a mechanical force screw, producing extra power with ease. The spring loaded plunger provides direct, non twisting application of thrust which is more effective and more secure



Loadstar Hydraulic Pullers

Various styles available including Loadstar 8, 12 & 20 tonne and Loadstar 'Plus' 20, 30 & 50 tonne. For heavy duty pulling and extracting



Mechanical Pullers

These use a mechanical force screw



Thin Jaw Pullers

These have special legs for use where clearance is limited behind the gear or bearing race. Available in both hydraulic and mechanical



Hub Pullers

Available in mechanical type with mechanical screw and also hydraulic with hydraulic ram. Sets to suit both light car and commercial vehicles. Additional legs and stud plates can be purchased if required



Blind Housing Bearing Removers

These operate without the need to dismantle machinery or remove the running shaft. Enables bearings to be removed from shafts when a long reach is required



Separators

For where all round support is required or where there is insufficient space for standard puller legs



Slide Hammers

Used when there is no shaft, making a conventional puller unsuitable



Split Collet Extractors

For blind housing internal use. The split collet is pushed into the centre of the bearing and then expanded via the hex nut on the end of the collet

Hydraulic 1500 Series

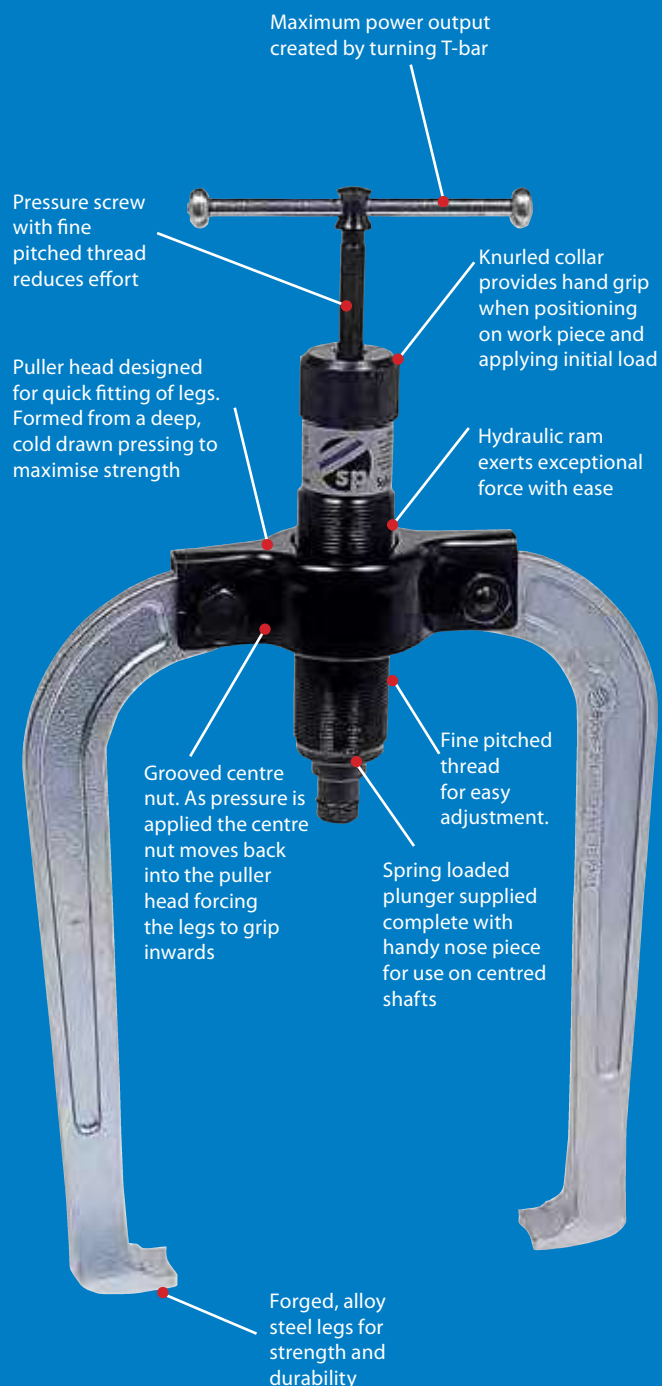

MECHANICAL GEAR



Mechanical Gear Pullers

- For the quick and safe removal of gears, races, bearings, pulleys, sprockets etc
- Essential service tools for all classes of industrial and automotive maintenance work
- Pressure on the force screw automatically increases the grip of legs
- The legs on the 6"/150mm and 8"/200mm pullers are double-ended enabling them to be reversed for internal and external applications, whilst on the larger pullers the legs can be adjusted to vary the length of reach
- Forged steel legs, beams and jaws, heat treated for additional strength and durability

TWIN LEG

- Two legs for removing gears, races, bearings and sprockets
- Can be upgraded for triple leg pulling
- Supplied in carton
- Refer to pages 167-170 for component illustrations

Specifications





Part No.	Spread Min - Max mm	Reach Max mm	Leg Style
083000	0 - 150	80	Double ended reversible
083100	0 - 200	140	
083200	0 - 300	250	Standard adjustable
083300	0 - 350	380	



TRIPLE LEG

- Three legs for removing gears, races, bearings and sprockets
- Supplied in carton
- Refer to pages 167-170 for component illustrations

Specifications





 Part No.	 Spread Min - Max mm	 Reach Max mm	 Leg Style
082700	0 - 150	80	Double ended reversible
082800	0 - 200	140	
082900	0 - 300	250	Standard adjustable
083400	0 - 350	380	



TWIN/TRIPLE LEG

- Twin and triple head (changed from beam) and double ended legs for a wide range of pulling options (082705, 082805)
- Two way & three way combination in one beam (660375)
- Supplied in carton
- Refer to pages 167-170 for component illustrations

Specifications

 Part No.	 Spread Min - Max mm	 Reach Max mm	No. of Puller Combinations	 Leg Style
660375	0 - 100	75	4	Double ended reversible
082705	0 - 150	80	4	
082805	0 - 200	140	4	



Contents

Part No.	Part No.	Qty	Description
660375	660361	1	Forcing Screw
	660364	1	Twin/Triple Head
	082714	3	Leg Assembly-Reversible
082705	082711	1	Forcing Screw
	660362	1	Twin Head
	660363	1	Triple Head
	082714	3	Leg Assembly-Reversible
082805	082811	1	Forcing Screw
	082812	1	Twin Head
	082813	1	Triple Head
	082814	3	Leg Assembly-Reversible

MECHANICAL GEAR

MINI - Twin/Triple Leg

082300

Mini Bearing Puller - Twin/Triple

- Fine pitch force screw with built in 'T' bar for smooth operation
- Two position adjustable leg for further pulling option
- 1 tonne capacity

Specifications

Part No.	Spread Min - Max mm	Reach Max mm	Leg Style
082300	0 - 60	50	Standard adjustable



082300

082450

Mini Puller - 4 way

- Ideal for windscreen wiper arms
- Unique four way design allows for four different jaw widths to be selected
- Reversible and interchangeable legs
- Removable centrepiece for wider application coverage
- Capacity from 19-36mm



082450



Four Assembly Options

082150

Fast Fit Micro Puller

- For rapid removal of small bearings
- Covers a wide range of automotive and engineering applications including alternators/generators, domestic appliances, power tools and pumps
- Self-centring force screw with 'T' bar and 13mm hexagon drive
- Drop forged legs with independent leaf springs
- Securing collar tightens under load for positive, non slip pulling action
- Suitable for ISO referenced bearings
- 1 tonne capacity

Specifications

Part No.	Spread Min - Max mm	Reach Min - Max mm
082150	19 - 45	19 - 73

Contents

Part No.	Qty	Description
082103	1	Forcing Screw
082104	1	Nose Piece Extension
082105	3	Leg



082150



KITS - Twin/Triple Leg

Twin/Triple Reversible Leg Kit

- Twin and triple head (changed from beam) and double ended legs for a wide range of pulling options
- Contains both **082705** and **082805** twin/triple leg pullers
- Supplied in metal case (**084900**) or carton (**084903**)
- Refer to pages 167-170 for component illustrations

Specifications

Part No.	Spread Min - Max mm	Reach Max mm	No. of Puller Combinations	Leg Style	Pkg
084900	0 - 200	140	4	Double ended reversible	Metal
084903	0 - 200	140	4		Carton

Contents **084900 & 084903**

Part No.	Qty	Description
082711	1	Forcing Screw
082811	1	Forcing Screw
660362	1	Twin Head
082812	1	Twin Head
660363	1	Triple Head
082813	1	Triple Head
082714	3	Leg Assembly-Reversible
082814	3	Leg Assembly-Reversible



084200

Mechanical Twin/Triple Leg Kit

- Makes 12 separate mechanical 2 or 3 leg pullers
- Twin and triple heads, double ended reversible and standard adjustable legs
- For a wide range of pulling options
- Supplied in metal case
- Refer to pages 167-170 for component illustrations

Specifications

Part No.	Spread Min - Max mm	Reach Max mm	No. of Puller Combinations	Leg Style
084200	0 - 350	380	12	Double ended reversible/standard adjustable



Contents

Part No.	Qty	Description	Part No.	Qty	Description
082711	1	Forcing Screw	082814	3	Leg Assembly - Reversible
660362	1	Twin Head	082911	1	Forcing Screw
660363	1	Triple Head	082912	1	Twin Head
082714	3	Leg Assembly - Reversible	082913	1	Triple Head
082811	1	Forcing Screw	082914	3	Leg Assembly - Standard Adjustable
082812	1	Twin Head	083314	3	Leg Assembly - Standard Adjustable
082813	1	Triple Head			

MECHANICAL GEAR

KITS - Twin/Triple Leg cont.

Combi-Puller System

- Many puller/leg assembly combinations available
- Graduated beam for accurate leg positioning
- Legs can be bolted together to extend reach
- Four different leg shapes to cover wide application
- Available as twin or triple puller kit
- Available in 5 tonne and 10 tonne capacity
- Twin puller supplied in carton
- Triple puller supplied in sturdy metal box

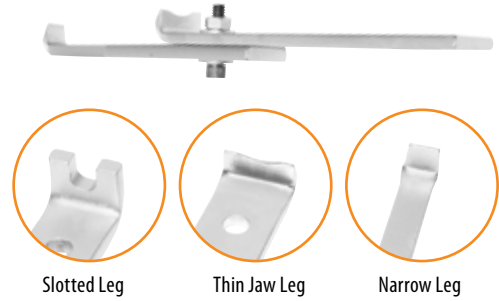

Specifications

Part No.	Kit Style	Spread Min - Max mm	Reach Max mm	Load Capacity	Weight
096050	Twin	10 - 173	140	5	2.7
096100	Twin	20 - 250	182	10	6
096350	Triple	10 - 173	140	5	4
096450	Triple	20 - 250	182	10	9

Contents

Kit Part No.	Part No.	Qty	Description
096050	096011	1	5T Force Screw
	096012	1	5T Twin Head
	096053	2	5T Narrow Leg - Long
	096054	2	5T Slotted Leg - Short
	096055	2	5T Thin Jaw Leg - Short
	096056	2	5T Thin Jaw Leg - Long
	096016	1	5T Leg Clips - Set of 4
	096014	2	5T Connecting Bolt Assembly
096100	096111	1	10T Force Screw
	096112	1	10T Twin Head
	096153	2	10T Narrow Leg - Long
	096154	2	10T Slotted Leg - Short
	096155	2	10T Thin Jaw Leg - Short
	096156	2	10T Thin Jaw Leg - Long
	096116	1	10T Leg Clips - Set of 4
	096114	2	10T Connecting Bolt Assembly
096350	096011	1	5T Force Screw
	096013	1	5T Triple Head
	096053	3	5T Narrow Leg - Long
	096054	3	5T Slotted Leg - Short
	096055	3	5T Thin Jaw Leg - Short
	096056	3	5T Thin Jaw Leg - Long
	096016	1	5T Leg Clips - Set of 4
	096014	3	5T Connecting Bolt Assembly
096450	096111	1	10T Force Screw
	096113	1	10T Triple Head
	096153	3	10T Narrow Leg - Long
	096154	3	10T Slotted Leg - Short
	096155	3	10T Thin Jaw Leg - Short
	096156	3	10T Thin Jaw Leg - Long
	096116	1	10T Leg Clips - Set of 4
	096114	3	10T Connecting Bolt Assembly



KITS - Twin/Triple Leg & Separator

084906

Mechanical Puller & Separator Kit

- Makes 8 separate mechanical 2 leg or 3 leg pullers with 2 bearing separator options
- Double ended reversible legs for a wide range of pulling options
- Supplied in metal case
- Refer to pages 167-170 for component illustrations

Specifications

Part No.	Spread Min - Max mm	Reach Max mm	External Spread Max mm	Leg Style
084906	200	140	105	Double ended reversible

Contents

Part No.	Qty	Description
082711	1	Forcing Screw
082714	3	Leg Assembly - Reversible
082811	1	Forcing Screw
082812	1	Twin Head
082813	1	Triple Head
082814	3	Leg - Double Ended Reversible
095000	1	Separator 10-55mm
095100	1	Separator 20-105mm
660362	1	Twin Head
660363	1	Triple Head



MECHANICAL GEAR

KITS - Twin/Triple Leg & Separator cont.

084206





Mechanical Puller & Separator Kit

- Makes 12 separate mechanical 2 or 3 leg pullers with 3 bearing separator options
- Twin and triple heads and double ended reversible legs for a wide range of pulling options
- Supplied in metal case
- Refer to pages 167-170 for component illustrations



084206

Specifications

 Part No.	 Spread Max mm	 Reach Max mm	 External Spread Max mm	 Leg Style
084206	350	380	140	Double ended reversible/standard adjustable

Contents

Part No.	Qty	Description	Part No.	Qty	Description
082711	1	Forcing Screw	082911	1	Forcing Screw
660362	1	Twin Head	082912	1	Twin Head
660363	1	Triple Head	082913	1	Triple Head
082714	3	Leg Assembly - Reversible	082914	3	Leg Assembly - Standard Adjustable
082811	1	Forcing Screw	083314	3	Leg Assembly - Standard Adjustable
082812	1	Twin Head	095000	1	Separator 10-55mm
082813	1	Triple Head	095100	1	Separator 20-105mm
082814	3	Leg Assembly - Reversible	095200	1	Separator 35-140mm

094003





Multi Puller Pack

- Makes 5 different mechanical puller/separator combinations
- Consists of a thin jaw puller, reversible leg puller and bearing separator - the ideal combination for light applications
- Supplied in carton with foam inlays
- Refer to pages 167-170 for component illustrations



094003

Specifications

 Part No.	 Spread Max mm	 Reach Max mm	 External Spread Max mm	 Leg Style
094003	140	89	55	Double ended reversible/thin jaw

Contents

Part No.	Qty	Description	Part No.	Qty	Description
082718	2	M8 X 30 Bolt & Nut	660361	1	Forcing Screw
082811	1	Forcing Screw	095000	1	Separator 10-55mm
086014	2	Leg 75mm - Thin Jaw	660362	1	Twin Head
093012	1	Twin Beam	660363	1	Triple Head
093015	2	Main Rod	082714	3	Leg - Double Ended Reversible

MECHANICAL THIN JAW GEAR







Thin Jaw Pullers

- Specially designed leg jaw profile for pulling tasks where there is limited clearance behind the component to be removed. The jaw profile also features a wider load bearing surface than standard puller legs in order to provide a secure grip
- Manufactured to the same high specifications as the standard leg and using the same materials
- Available with either mechanical or 1500 series hydraulic power (see hydraulic section page 118)

TWIN LEG - Thin Jaw

- Two legs for removing gears, races, bearings and sprockets
- Can be upgraded for triple leg pulling
- Supplied in carton
- Refer to pages 167-170 for component illustrations

Specifications

 Part No.	 Spread Min - Max mm	 Reach Max mm	 Leg Style
086000	0 - 75	75	Thin Jaw
086020*	0 - 75	125	
086100	0 - 150	150	
086200	0 - 225	225	
086300	0 - 150	225	





* Includes force screw extension (50mm).



TRIPLE LEG - Thin Jaw

- Three legs for removing gears, races, bearings and sprockets
- Supplied in carton
- Refer to pages 167-170 for component illustrations

Specifications

 Part No.	 Spread Min - Max mm	 Reach Max mm	 Leg Style
086010	0 - 75	75	Thin Jaw
086030*	0 - 75	125	
086400	0 - 150	150	
086500	0 - 150	225	

* Includes force screw extension (50mm).



MECHANICAL THIN JAW GEAR





KITS - Thin Jaw Twin/Triple Leg

086003

Mechanical Puller Kit - Thin Jaw

- Makes 4 mechanical 2 or 3 leg pullers
- Thin jaws enable access where clearance behind components is limited
- Supplied in carton
- Refer to pages 167-170 for component illustrations

Specifications

 Part No.	 Spread Max mm	 Reach Max mm	No. of Puller Combinations	 Leg Style
086003	75	115	4	Thin Jaw

Contents

Part No.	Qty	Description
082711	1	Forcing Screw
086012	1	Twin Beam
086013	1	Triple Beam
086014	3	Leg 75mm - Thin Jaw
086016	1	Extension
086024	3	Leg 110mm - Thin Jaw







086504

Mechanical Puller Kit - Thin Jaw

- Contains components to make up 7 thin jaw leg pullers
- Thin jaws enable access where clearance behind components is limited
- Also available on display panel **086505**, see page 156
- Refer to pages 167-170 for component illustrations

Specifications

 Part No.	 Spread Max mm	 Reach Max mm	No. of Puller Combinations	 Leg Style
086504	184	225	7	Thin Jaw

Contents

Part No.	Qty	Description
086111	1	Forcing Screw
082911	1	Forcing Screw
086000	1	Puller - Thin Jaw
086112	1	Twin Beam
086212	1	Twin Beam
086513	1	Triple Beam
086114	3	Leg 150mm - Thin Jaw
086214	3	Leg 225mm - Thin Jaw



MECHANICAL THIN JAW GEAR

KITS - Thin Jaw Puller & Separator

093003

Mechanical Puller & Separator Kit - Thin Jaw

- Combination small capacity puller and bearing separator pack
- Thin jaws enable access where clearance behind component is limited
- Supplied in carton
- Refer to pages 167-170 for component illustrations

Specifications

Part No.	Spread Max mm	Reach Max mm	External Spread Max mm	Leg Style
093003	75	115	55	Thin Jaw

Contents

Part No.	Qty	Description
082300	1	Mini Bearing Puller
086014	2	Leg 75mm - Thin Jaw
086024	2	Leg 110mm - Thin Jaw
082811	1	Forcing Screw
093012	1	Twin Beam
093015	2	Main Rod
095000	1	Separator 10-55mm



093003

093005

Mechanical Puller & Separator Kit - Thin Jaw

- Pulling unit with small capacity bearing separator and thin jaw legs will remove bearings inaccessible to standard puller jaws
- Supplied in carton
- Refer to pages 167-170 for component illustrations

Specifications

Part No.	Spread Max mm	Reach Max mm	External Spread Max mm	Leg Style
093005	75	75	55	Thin Jaw

Contents

Part No.	Qty	Description
082811	1	Forcing Screw
086014	2	Leg 75mm - Thin Jaw
093012	1	Beam Twin
093015	2	Main Rod
095000	1	Separator 10-55mm



093005

HYDRAULIC GEAR



Hydraulic Gear Pullers

- Ideal for wide range of automotive and industrial applications including gear pulling, bearing extraction and hub removal
- Powered by the 1500 series hydraulic ram – applies 8 tonnes of force with ease
- Three basic components – the ram, a twin head and a triple head – provide the basis for a highly versatile pulling system. Capacity can be varied simply by changing legs and additional attachments are available for hub and bearing pulling. Unnecessary duplication of parts is avoided
- Safe and easy to use, simple to adjust, self centring and self locking
- Non-twisting for improved stability
- Forged alloy steel legs for strength and durability

1500 SERIES HYDRAULIC RAM

150000

1500 Series Hydraulic Ram

- Grease filled
- Direct force improves stability under load
- Provides maximum withdrawal force of 80 KN

Part No.	Qty	Description
150000	1	Hydraulic Ram
	1	Nose Piece

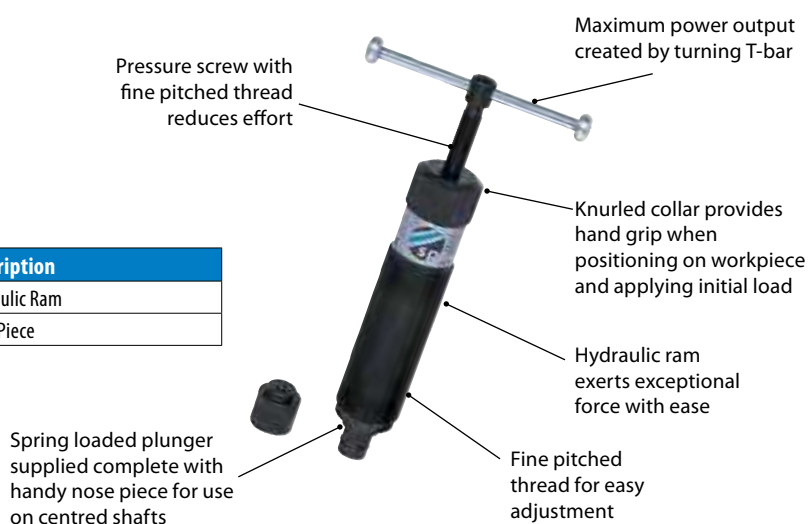

150024

1500 Series Hydraulic Ram Repair Kit

- Contains seals and grease required to repair **150000** Hydraulic Ram
- Supplied with installation manual



127300

Hydraulic Ram Converter

- Converts the 1500 series hydraulic ram to mechanical, using forcing screw and shock handle
- In addition the impact shock handle to screw has a sliding centre spindle which allows the operator to strike the end when fully loaded. This assists the release of stubborn joints or taper fits

Contents





Part No.	Qty	Description
082519	1	Shock Handle 203mm
127311	1	Forcing Screw 285mm 1.5" X 16 BSW



TWIN LEG

- Two legs for removing gears, bearings, pulleys and sprockets
- Supplied with nose piece for use on centred shafts
- Can be upgraded for triple leg pulling
- Supplied in carton
- Refer to pages 171-175 for component illustrations

Specifications





 Part No.	 Puller Spread Min-Max mm	 Puller Reach Max mm	 Ram Extension mm	 Leg Style
152400	50 - 100	100	50	Standard
152600	75 - 150	150	100	
152700	75 - 150	250	150	
152800	100 - 200	200	150	
152900	130 - 250	250	150	



TRIPLE LEG

- Three legs for removing gears, bearings, pulleys and sprockets
- Supplied with nose piece for use on centred shafts
- Supplied in carton
- Refer to pages 171-175 for component illustrations

Specifications

 Part No.	 Puller Spread Min-Max mm	 Puller Reach Max mm	 Ram Extension mm	 Leg Style
153400	50 - 100	100	50	Standard
153600	75 - 150	150	100	
153700	75 - 150	250	150	
153800	100 - 200	200	150	
153900	130 - 250	250	150	

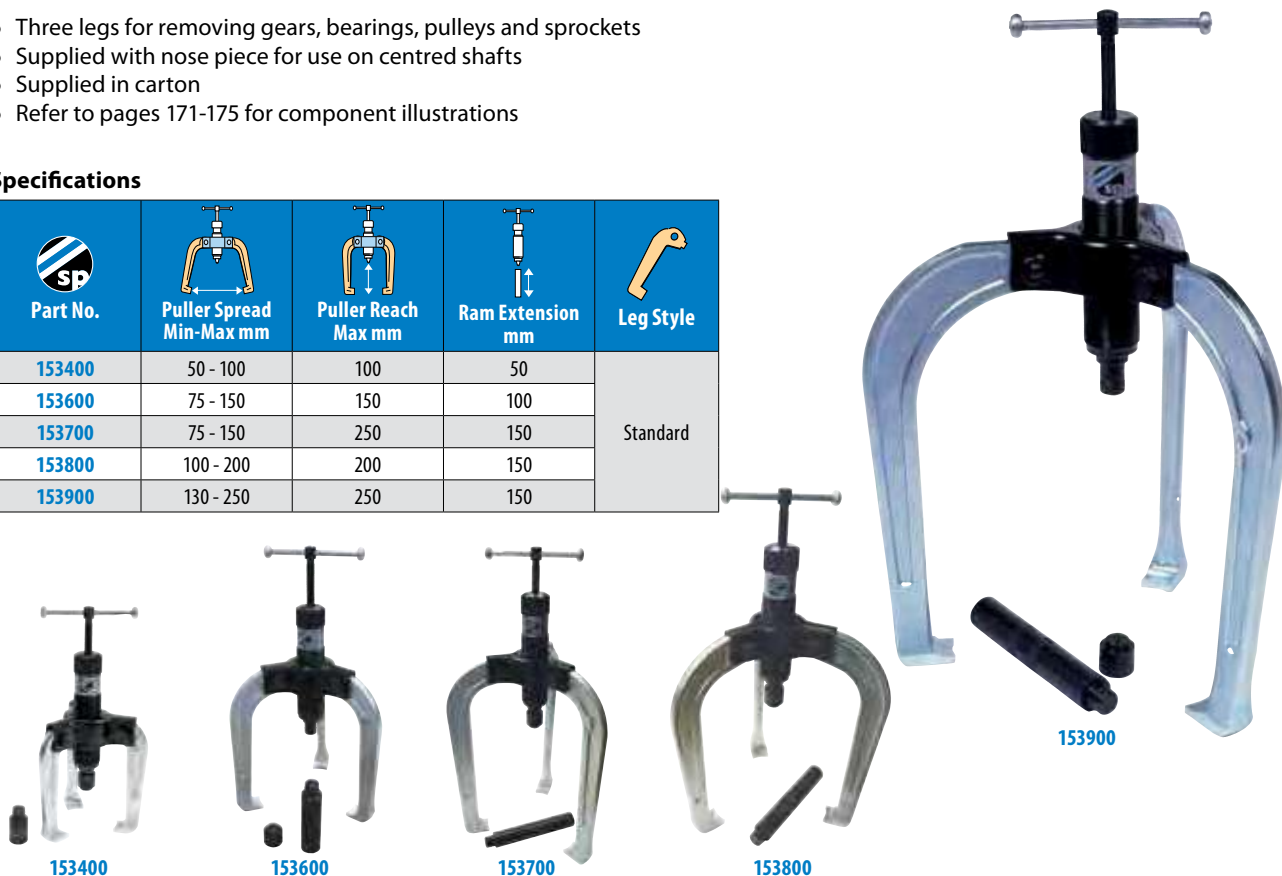

PULLERS

HYDRAULIC GEAR



KITS - Twin/Triple Leg

154900

Hydraulic Twin Leg Kit

- Makes 2 different pullers
- Self centring and self locking
- Refer to pages 171-175 for component illustrations

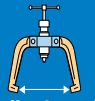
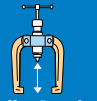
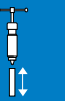
Specifications

				
Part No.	Puller Spread Min-Max mm	Puller Reach Max mm	Ram Extension mm	Leg Style
154900	75 - 100	150	50 / 100	Standard

Contents

Part No.	Qty	Description
150000	1	Hydraulic Ram With Nose Piece
152412	1	Twin Head
152422	1	Ram Extension - 50mm
152624	1	Ram Extension - 100mm
152424	2	Leg 100mm
152626	2	Leg 150mm





154900

153405

Hydraulic Twin/Triple Leg Kit

- Combination twin/triple leg puller kit complete with ram extension offers a wide range of pulling options
- Makes 2 different twin/triple leg pullers
- Wide range of kits to suit most applications
- Supplied in carton
- Refer to pages 171-175 for component illustrations

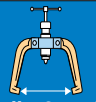
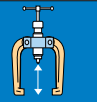
Specifications

				
Part No.	Puller Spread Min-Max mm	Puller Reach Max mm	Ram Extension mm	Leg Style
153405	50 - 100	100	50	Standard

Contents

Part No.	Qty	Description
150000	1	Hydraulic Ram With Nose Piece
152412	1	Twin Head
153413	1	Triple Head
152422	1	Ram Extension - 50mm
152424	3	Leg - 100mm







153405

155000 & 155003

Hydraulic Twin/Triple Leg Kits

- Makes 3 different twin/triple leg pullers
- Supplied in metal case (155000) or in carton (155003)
- Refer to pages 171-175 for component illustrations

Specifications

 Part No.	 Puller Spread Min-Max mm	 Puller Reach Max mm	 Ram Extension mm	 Leg Style	Pkg
155000	75 - 150	150	50 / 100	Standard	Metal
155003	75 - 150	150	50 / 100	Standard	Carton

Contents

Part No.	Qty	Description
150000	1	Hydraulic Ram With Nose Piece
152412	1	Twin Head
153413	1	Triple Head
152422	1	Ram Extension - 50mm
152624	1	Ram Extension - 100mm
152424	3	Leg - 100mm
152626	3	Leg - 150mm







155000 & 155003

155008

Hydraulic Twin/Triple Leg Kit

- Makes 6 different twin/triple leg pullers
- Supplied in metal case
- Refer to pages 171-175 for component illustrations

Specifications

 Part No.	 Puller Spread Min-Max mm	 Puller Reach Max mm	 Ram Extension mm	 Leg Style
155008	50 - 200	200	50 / 100	Standard

Contents

Part No.	Qty	Description
150000	1	Hydraulic Ram with Nose Piece
152412	1	Twin Head
153413	1	Triple Head
152422	1	Ram Extension - 50mm
152624	1	Ram Extension - 100mm
152424	3	Leg - 100mm
152626	3	Leg - 150mm
152828	3	Leg - 200mm



155008

HYDRAULIC GEAR





KITS - Twin/Triple Leg cont.

155100

Hydraulic Twin/Triple Leg Puller Kit

- Makes 10 different twin/triple leg pullers
- Supplied in metal case
- Refer to pages 171-175 for component illustrations

Specifications

				
Part No.	Puller Spread mm	Puller Reach Max mm	Ram Extension mm	Leg Style
155100	50 - 250	250	50 / 100 / 150	Standard

Contents

Part No.	Qty	Description
150000	1	Hydraulic Ram With Nose Piece
152412	1	Twin Head
153413	1	Triple Head
152422	1	Ram Extension - 50mm
152624	1	Ram Extension - 100mm
152726	1	Ram Extension - 150mm
152424	3	Leg - 100mm
152626	3	Leg - 150mm
152828	3	Leg - 200mm
152727	3	Leg - 250mm
152929	3	Leg - 250mm (extra wide)







KITS - Combination Twin/Triple Leg

154003

Hydraulic Combination Twin Leg Kit

- Makes 4 different hydraulic pullers
- Combination standard and thin jaw leg puller
- Refer to pages 171-175 for component illustrations

Specifications

				
Part No.	Puller Spread mm	Puller Reach Max mm	Ram Extension mm	Leg Style
154003	50 - 150	225	50 / 100	Standard/Thin Jaw

Contents

Part No.	Qty	Description
150000	1	Hydraulic Ram With Nose Piece
152412	1	Twin Head Assembly
193112	1	Twin Beam
152422	1	Ram Extension – 50mm
152624	1	Ram Extension – 100mm
152424	2	Leg - 100mm
152626	2	Leg - 150mm
086114	2	Leg 150mm - Thin Jaw
086214	2	Leg 225mm - Thin Jaw







154003

155004

Hydraulic Combination Twin/Triple Leg Kit

- Makes 8 different hydraulic pullers
- Combination standard and thin jaw leg puller
- Supplied in metal case
- Refer to pages 171-175 for component illustrations

Specifications

				
Part No.	Puller Spread mm	Puller Reach Max mm	Ram Extension mm	Leg Style
155004	50 - 225	225	50 / 100	Standard / Thin Jaw

Contents

Part No.	Qty	Description
150000	1	Hydraulic Ram With Nose Piece
152412	1	Twin Head Assembly
193112	1	Twin Beam
153413	1	Triple Head Assembly
186513	1	Triple Beam
152422	1	Ram Extension – 50mm
152624	1	Ram Extension – 100mm
152424	3	Leg - 100mm
152626	3	Leg - 150mm
086114	3	Leg 150mm - Thin Jaw
086214	3	Leg 225mm - Thin Jaw



155004

HYDRAULIC GEAR





KITS - Twin/ Triple Leg & Separator

193100

Hydraulic Separator Kit

- Versatile tool where a long reach is required to draw a bearing from a shaft
- Also available without hydraulic ram as kit **193101** (in carton)
- The tapered edges of the bearing separator provide all round support and can fit behind bearings where normal puller legs cannot gain access
- Supplied in metal case
- Refer to pages 171-175 for component illustrations

Specifications

 Part No.	 External Spread Min-Max mm	 External Reach Max mm	 Ram Extension mm
193100	20 - 105	876	100

Contents

Part No.	Qty	Description
150000	1	Hydraulic Ram With Nose Piece
152624	1	Ram Extension - 100mm
193112	1	Twin Beam
095100	1	Separator 20-105mm
093115	2	Main Rod
093119	4	Extension Rod
093123	2	Extension Rod 5 inch







193200

Hydraulic Separator Kit - Heavy Duty

- Versatile tool where a long reach is required to draw a bearing from a shaft
- Also available without hydraulic ram as kit **193201** (in carton)
- The tapered edges of the bearing separator provide all round support and can fit behind bearings where normal puller legs cannot gain access
- Supplied in metal case
- Refer to pages 171-175 for component illustrations

Specifications

 Part No.	 External Spread Min-Max mm	 External Reach Max mm	 Ram Extension mm
193200	35 - 140	863	150

Contents

Part No.	Qty	Description
150000	1	Hydraulic Ram With Nose Piece
152726	1	Ram Extension - 150mm
193212	1	Twin Beam
095200	1	Separator 35-140mm
093215	2	Main Rod
093219	4	Extension Rod
093223	2	Extension Rod 5 inch







156000

Hydraulic Internal/External Puller & Separator Kit

- For removing bearings, gears etc. where access behind components is too restricted to use standard pullers
- Drop forged, high quality steel, heat treated for strength and durability
- Separators have tapered edge for insertion behind close fitting bearings, gears etc
- Internal puller has screw adjustable legs for positive fit
- Supplied in metal case
- Refer to pages 171-175 for component illustrations

Specifications

			
Part No.	External Spread Min-Max mm	External Reach Min-Max mm	Ram Extension mm
156000	35 - 140	40 - 150	863

Contents

Part No.	Qty	Description
150000	1	Hydraulic Ram With Nose Piece
152726	1	Ram Extension - 150mm
193212	1	Twin Beam
095200	1	Separator 35-145mm
093215	2	Main Rod
093219	4	Extension Rod
093223	2	Extension Rod 5 inch
093500	1	Internal Race Extractor

Part No.	Qty	Description
093111	1	Forcing Screw c/w Nut
093121	1	Thrust Race
093122	1	Convertor
093220	2	Protector









155200

Hydraulic Puller & Separator Kit

- Makes 4 different twin/triple leg pullers, plus bearing separator kit
- Supplied in metal case
- Refer to pages 171-175 for component illustrations

Specifications

					
Part No.	Puller Spread Min-Max mm	Puller Reach Max mm	External Spread Min-Max mm	External Reach Max mm	Leg Style
155200	50 - 150	150	20 - 105	876	Standard

Contents

Part No.	Qty	Description
150000	1	Hydraulic Ram With Nose Piece
152412	1	Twin Head
153413	1	Triple Head
152422	1	Ram Extension - 50mm
152624	1	Ram Extension - 100mm
152424	3	Leg - 100mm
152626	3	Leg - 150mm
193112	1	Twin Beam
095100	1	Separator 20-105mm

Part No.	Qty	Description
093115	2	Main Rod
093119	4	Extension Rod
093123	2	Extension Rod 5 inch



HYDRAULIC GEAR

KITS - Twin/Triple Leg & Separator cont.

155208

Hydraulic Puller & Separator Kit

- Makes 6 different twin/triple leg pullers, plus bearing separator kit
- Supplied in metal case
- Refer to pages 171-175 for component illustrations

Specifications

Part No.	Puller Spread Min-Max mm	Puller Reach Max mm	External Spread mm	External Reach Max mm	Leg Style
155208	50 - 200	200	20 - 105	876	Standard

Contents

Part No.	Qty	Description
150000	1	Hydraulic Ram With Nose Piece
152412	1	Twin Head
153413	1	Triple Head
152422	1	Ram Extension - 50mm
152624	1	Ram Extension - 100mm
152424	3	Leg - 100mm
152626	3	Leg - 150mm
152828	3	Leg - 200mm
193112	1	Twin Beam
095100	1	Separator 20-105mm
093115	2	Main Rod
093119	4	Extension Rod
093123	2	Extension Rod 5 inch



155400

Hydraulic Puller & Separator Kit

- Versatile tool where a long reach is required to draw a bearing from a shaft
- The tapered edges of the bearing separator provide all round support and can fit behind bearings where normal puller legs cannot gain access
- Supplied in metal case
- Refer to pages 171-175 for component illustrations
- Also available on display panel **155405**, see page 159

Specifications

Part No.	Puller Spread Min-Max mm	Puller Reach Max mm	External Spread mm	External Reach Max mm	Leg Style
155400	50 - 200	200	20 - 105	876	Standard



155405

Contents

Part No.	Qty	Description
150000	1	Hydraulic Ram With Nose Piece
152412	1	Twin Head
153413	1	Triple Head
152422	1	Ram Extension - 50mm
152624	1	Ram Extension - 100mm
152726	1	Ram Extension - 150mm
152424	3	Leg - 100mm
152626	3	Leg - 150mm
152828	3	Leg - 200mm
152727	3	Leg - 250mm
152929	3	Leg - 250mm (Extra Wide)
193112	1	Twin Beam
095100	1	Separator 20-105mm
093115	2	Main Rod
093119	4	Extension Rod
093123	2	Extension Rod 5 inch



155400

HYDRAULIC GEAR

KITS - Twin/Triple Leg & Separator cont.

155700

Hydraulic Internal Extractor, Puller & Separator Kit

- Makes 10 different twin/triple leg pullers, plus bearing separator kit and internal extractor kit
- Supplied in metal case
- Refer to pages 171-175 for component illustrations

Specifications

Part No.	Puller Spread Min-Max mm	Puller Reach Max mm	External Spread mm	External Reach Max mm	Leg Style
155700	20 - 200	250	20 - 105	876	Standard

Contents

Part No.	Qty	Description
150000	1	Hydraulic Ram with Nose Piece
152412	1	Twin Head
153413	1	Triple Head
152422	1	Ram Extension - 50mm
152624	1	Ram Extension - 100mm
152726	1	Ram Extension - 150mm
152424	3	Leg - 100mm
152626	3	Leg - 150mm
152828	3	Leg - 200mm
152727	3	Leg - 250mm
152929	3	Leg - 250mm (extra wide)
193112	1	Twin Beam
095100	1	Separator 20-105mm
093115	2	Main Rod
093119	4	Extension Rod
093123	2	Extension Rod 5 inch
093500	1	Internal Race Extractor
093111	1	Forcing Screw c/w Nut
093121	1	Thrust Race
093122	1	Converter
093120	2	Protector









155700

155800

Hydraulic Internal Extractor, Puller & Heavy Duty Separator Kit

- Makes 10 different twin/triple leg pullers, plus heavy duty bearing separator kit and internal extractor kit
- Supplied in metal case
- Refer to pages 171-175 for component illustrations

Specifications

 Part No.	 Puller Spread Min-Max mm	 Puller Reach Max mm	 External Spread mm	 External Reach Max mm	 Leg Style
155800	35 - 250	250	35 - 140	863	Standard

Contents

Part No.	Qty	Description
150000	1	Hydraulic Ram With Nose Piece
152412	1	Twin Head
153413	1	Triple Head
152422	1	Ram Extension - 50mm
152624	1	Ram Extension - 100mm
152726	1	Ram Extension - 150mm
152424	3	Leg - 100mm
152626	3	Leg - 150mm
152828	3	Leg - 200mm
152727	3	Leg - 250mm
152929	3	Leg - 250mm (Extra Wide)
193212	1	Twin Beam
095200	1	Separator 35-145mm
093215	2	Main Rod
093219	4	Extension Rod
093223	2	Extension Rod 5 inch
093500	1	Internal Race Extractor
093111	1	Forcing Screw c/w Nut
093121	1	Thrust Race
093122	1	Convertor
093220	2	Protector



155800

HYDRAULIC GEAR

KITS - Twin/Triple Leg & Separator cont.

155900

Hydraulic Internal Extractor, Puller & Separator Kit - Master Set

- Makes 10 different twin/triple leg pullers, plus heavy duty bearing separator kit and internal extractor kit
- Supplied in metal case
- Refer to pages 171-175 for component illustrations

Specifications

Part No.	Puller Spread mm	Puller Reach Max mm	External Spread mm	External Reach Max mm	Leg Style
155900	20 - 250	250	20 - 140	876	Standard

Contents

Part No.	Qty	Description	Part No.	Qty	Description
150000	1	Hydraulic Ram With Nose Piece	093119	4	Extension Rod
152412	1	Twin Head	093123	2	Extension Rod 5 inch
153413	1	Triple Head	193212	1	Twin Beam
152422	1	Ram Extension - 50mm	095200	1	Separator 35-145mm
152624	1	Ram Extension - 100mm	093215	2	Main Rod
152726	1	Ram Extension - 150mm	093219	4	Extension Rod
152424	3	Leg - 100mm	093223	2	Extension Rod 5 inch
152626	3	Leg - 150mm	093500	1	Internal Race Extractor
152828	3	Leg - 200mm	093111	1	Forcing Screw c/w Nut
152727	3	Leg - 250mm	093121	1	Thrust Race
152929	3	Leg - 250mm (Extra Wide)	093122	1	Convertor
193112	1	Twin Beam	093120	2	Protector
095100	1	Separator 20-105mm	093220	2	Protector
093115	2	Main Rod			



155900

HYDRAULIC THIN JAW GEAR



Hydraulic Thin Jaw Pullers

- Designed for pulling jobs where clearance behind the component is limited. These jobs often require wide bearing surfaces on the jaws to give a secure grip - the thin jaw range meets these requirements
- Powered by the 1500 series hydraulic ram - applies 8 tonnes of force with ease
- Safe and easy to use, simple to adjust, self centring and self locking
- Non-twisting for improved stability
- Forged alloy steel legs for strength and durability

TWIN LEG - Thin Jaw

- Two legs for removing gears, bearings, pulleys and sprockets
- Can be upgraded for triple leg pulling
- Thin jaws enable access where clearance behind components is limited
- Supplied in carton
- Refer to pages 171-175 for component illustrations

Specifications

Part No.	Puller Spread Min-Max mm	Puller Reach Max mm	Ram Extension mm	Leg Style
186100	50 - 150	150	50	Thin Jaw
186300	50 - 150	225	150	
186200	50 - 225	225	150	



TRIPLE LEG - Thin Jaw

- Three legs for removing gears, bearings, pulleys and sprockets
- Thin jaws enable access where clearance behind components is limited
- Supplied in carton
- Refer to pages 171-175 for component illustrations

Specifications

Part No.	Puller Spread Min-Max mm	Puller Reach Max mm	Ram Extension mm	Leg Style
186400	50 - 150	150	50	Thin Jaw
186500	50 - 150	225	150	



HYDRAULIC THIN JAW GEAR





KITS - Thin Jaw Twin/Triple Leg

186504

Hydraulic Twin/Triple Leg Puller Kit - Thin Jaw

- Makes 5 different hydraulic and 1 mechanical thin jaw puller
- Supplied in metal case
- Refer to pages 171-175 for component illustrations
- Also available on display panel **186505**, see page 157

Specifications

				
Part No.	Puller Spread Min-Max mm	Puller Reach Max mm	Ram Extension mm	Leg Style
186504	50 - 225	225	50 / 150	Thin Jaw

Contents

Part No.	Qty	Description
150000	1	Hydraulic Ram With Nose Piece
152422	1	Ram Extension - 50mm
152726	1	Ram Extension - 150mm
086012	1	Twin Beam
186212	1	Twin Beam
186513	1	Triple Beam
193112	1	Twin Beam
086014	2	Leg 75mm - Thin Jaw
086214	3	Leg 225mm - Thin Jaw
082711	1	Forcing Screw 12 X 1.75 X 150mm
086114	3	Leg 150mm - Thin Jaw



186505



186504





KITS - Combination Twin/Triple Leg

154003

Hydraulic Combination Twin Leg Kit

- Makes 4 different hydraulic pullers
- Combination standard and thin jaw leg puller
- Refer to pages 171-175 for component illustrations

Specifications

				
Part No.	Puller Spread Min-Max mm	Puller Reach Max mm	Ram Extension mm	Leg Style
154003	50 - 150	225	50 / 100	Standard/Thin Jaw

Contents

Part No.	Qty	Description
150000	1	Hydraulic Ram With Nose Piece
152412	1	Twin Head Assembly
193112	1	Twin Beam
152422	1	Ram Extension - 50mm
152624	1	Ram Extension - 100mm
152424	2	Leg - 100mm
152626	2	Leg - 150mm
086114	2	Leg 150mm - Thin Jaw
086214	2	Leg 225mm - Thin Jaw



154003

HYDRAULIC THIN JAW GEAR

155004

Hydraulic Combination Twin/Triple Leg Kit

- Makes 8 different hydraulic pullers
- Combination standard and thin jaw leg puller
- Supplied in metal case
- Refer to pages 171-175 for component illustrations



155004

Specifications

Part No.	Puller Spread Min-Max mm	Puller Reach Max mm	Ram Extension mm	Leg Style
155004	50 - 225	225	50 / 100	Standard/Thin Jaw

Contents

Part No.	Qty	Description	Part No.	Qty	Description
150000	1	Hydraulic Ram With Nose Piece	152624	1	Ram Extension – 100mm
152412	1	Twin Head Assembly	152424	3	Leg - 100mm
193112	1	Twin Beam	152626	3	Leg - 150mm
153413	1	Triple Head Assembly	086114	3	Leg 150mm - Thin Jaw
186513	1	Triple Beam	086214	3	Leg 225mm - Thin Jaw
152422	1	Ram Extension – 50mm			

KITS - Thin Jaw Twin Leg & Separator

193103

Hydraulic Puller & Separator Kit - Thin Jaw

- Combination pack consisting of a medium duty hydraulic thin jaw puller and bearing separator
- Supplied in carton
- Refer to pages 171-175 for component illustrations
- Also available as **193104** kit without 150000 hydraulic ram*

Specifications

Part No.	Puller Spread Min-Max mm	Puller Reach Max mm	Ram Extension mm	Leg Style
193103	50 - 105	876	50 / 100 / 150	Thin Jaw

Contents

Part No.	Qty	Description
150000	1	Hydraulic Ram With Nose Piece*
152624	1	Ram Extension - 100mm
086114	2	Leg 150mm - Thin Jaw
193112	1	Twin Beam
095100	1	Separator 20-105mm
093115	2	Main Rod
093119	4	Extension Rod
093123	2	Extension Rod 5 inch

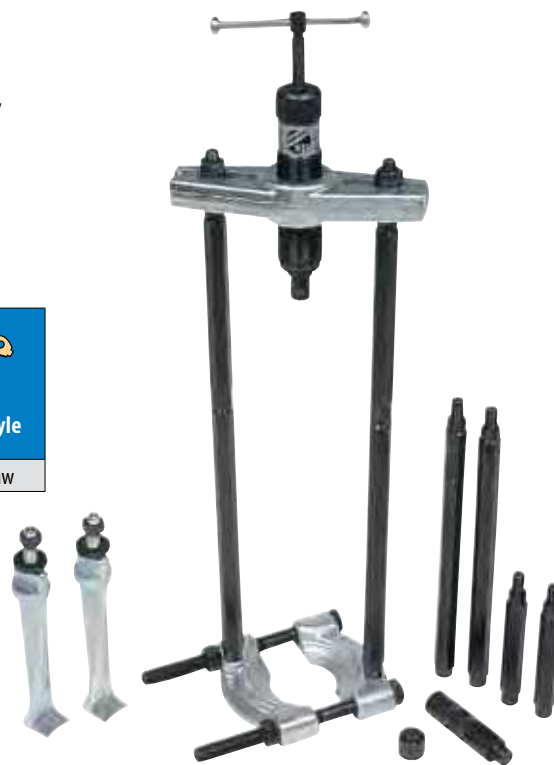

193103

LOADSTAR HEAVY DUTY



FEATURES

Loadstar Pullers

- Self centring self locking puller legs, grip increases as load increases
- Easy one man operation, 2 and 3 way options
- 360 degree swivel hose coupling for optimum access
- Lightweight aluminium hydraulic pump included
- Selection of ram extension rods supplied to increase stroke
- In-built safety valve to prevent overloading

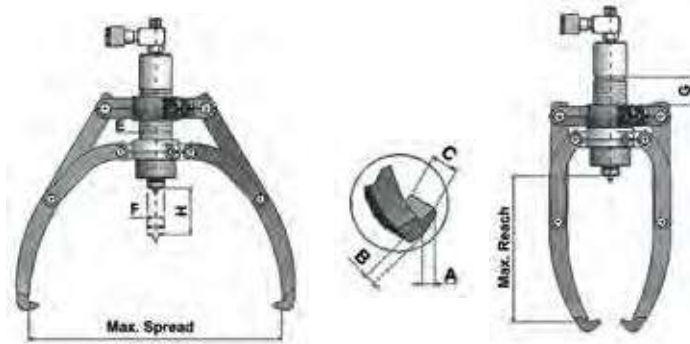

Specifications

Capacity Tonnes	Part No.	Puller Spread Max mm	Puller Reach Max mm	Stroke mm H	Ram Dia mm E	Nose Dia. mm F	Travel mm G	Jaw Tip mm A	Jaw Tip mm B	Jaw Tip mm C	Weight kg
8 Tonne	201008	450	280	85	50	25	70	13	13	27.5	26
12 Tonne	201012	485	305	85	60	28	70	15	16.5	29	36
20 Tonne	201020	570	365	111	80	40	62	20	27	33	66

LOADSTAR PULLERS

201008

Loadstar Puller 8 Tonne

- 8 tonne hydraulic ram and pump
- Selection of three ram extension rods supplied to increase stroke
- Spread 450mm
- Reach 280mm
- Puller supplied in sturdy plastic storage case
- Pump supplied in steel storage case
- See above for specifications

Contents

Part No.	Qty	Description
200170	1	Hydraulic Pump Assembly
217200	1	High Pressure Hose 1.8m Long
217900	1	Gauge & Gauge Block
20100810	1	8T Hydraulic Ram
20100814	1	Leg Assembly
20100812	1	Head Assembly - Upper
20100813	1	Head Assembly - Lower
20100820	1	Ram Extension Set (3 piece)



201008

LOADSTAR HEAVY DUTY

201012

Loadstar Puller 12 Tonne

- 12 tonne hydraulic ram and pump
- Selection of four ram extension rods supplied to increase stroke
- Spread 485mm
- Reach 305mm
- Puller supplied in sturdy plastic storage case
- Pump supplied in steel storage case
- See page 134 for specifications

Contents

Part No.	Qty	Description
200170	1	Hydraulic Pump Assembly
217200	1	High Pressure Hose 1.8m Long
217900	1	Gauge & Gauge Block
20101210	1	12T Hydraulic Ram
20101214	1	Leg Assembly
20101212	1	Head Assembly - Upper
20101213	1	Head Assembly - Lower
20101220	1	Ram Extension Set (4 piece)



201020

Loadstar Puller 20 Tonne

- 20 tonne hydraulic ram and pump
- Puller and pump supplied in steel storage case
- Selection of four ram extension rods supplied to increase stroke
- Spread 570mm
- Reach 365mm
- Supplied in steel storage cases
- See page 134 for specifications

Contents

Part No.	Qty	Description
200170	1	Hydraulic Pump Assembly
217200	1	High Pressure Hose 1.8m Long
217900	1	Gauge & Gauge Block
20102010	1	20T Hydraulic Ram
20102014	1	Leg Assembly
20102012	1	Head Assembly - Upper
20102013	1	Head Assembly - Lower
20102020	1	Ram Extension Set (4 piece)



PULLERS

LOADSTAR HEAVY DUTY



Loadstar "Plus" Pullers

- Loadstar "Plus" heavy duty pullers offer a comprehensive range of pulling and extracting options
- Available in 20 tonne, 30 tonne and 50 tonne
- Choices range from fully equipped comprehensive kits or entry level puller kits with the capability to add on extra packs as required
- These extra packs consist of separator packs, accessory packs and in the 20 tonne version there is also a press frame pack available
- The Loadstar "Plus" series is a versatile range with options to suit all heavy duty pulling and extraction situations

Loadstar "Plus" Specifications

Capacity Tonnes	Part No.	Pulling		External		Internal	200395 Press Frame				Stroke mm	Weight kg
		Spread mm	Reach mm	Spread Min - Max mm	Reach mm	Spread Min - Max mm	Throat		Extractor			
							Depth Min - Max mm	Width Min - Max mm	Pin Dia. Min - Max mm	Pin Length Min - Max mm		
20 Tonne	202000	530	760	-	-	-	-	-	-	-	152	88
	202001	530	760	-	-	-	-	-	-	-	152	83
	202020	-	-	50 - 175	420	-	-	-	-	-	152	54
	202040	-	-	-	-	-	365 - 460	165	18 - 50	17 - 150	152	47
	202045	530	760	50 - 175	420	75 - 225	-	-	-	-	152	150
	212000	-	-	-	-	-	365 - 460	165	18 - 50	17 - 150	152	71
	212001	-	-	-	-	-	365 - 460	165	18 - 50	17 - 150	152	65
	202050	530	760	50 - 175	420	75 - 225	365 - 460	165	18 - 50	17 - 150	152	195
30 Tonne	203000	530	580	-	-	-	-	-	-	-	50	92
	203001	530	580	-	-	-	-	-	-	-	50	86
	203020	-	-	50 - 175	860	-	-	-	-	-	50	63
	203050	530	580	50 - 175	860	75 - 225	-	-	-	-	50	160
50 Tonne	205000	530	470	-	-	-	-	-	-	-	50	106
	205001	530	470	-	-	-	-	-	-	-	50	100
	205020	-	-	50 - 175	750	-	-	-	-	-	50	68
	205050	530	470	50 - 175	750	75 - 225	-	-	-	-	50	180

200170 Hydraulic Pump Assembly Spare Parts

Part No.	Description
217200	High Pressure Hose 1.8m long
217400	Quick Coupling - Complete
217401	Quick Coupling - Male
217402	Quick Coupling - Female
217900	Gauge & Gauge Block
218000	Hydraulic Oil - 5 Litres

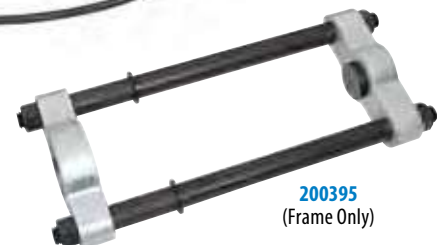

20 TONNE - Loadstar "Plus"

202000

20 Tonne Loadstar "Plus" Entry Level Kit

- 20 tonne hydraulic cylinder and pump
- Four pulling combinations
- Supplied in steel storage case
- 3 x cranked legs
- 3 x straight legs
- 3 x leg extensions
- Spread 530mm
- Reach 760mm
- See page 139 for kit contents
- See page 136 for specifications and hydraulic pump assembly spare parts



202001

20 Tonne Loadstar "Plus" Entry Level Kit (minus pump)

- 20 tonne hydraulic cylinder
- Capability as above for those customers who already have a suitable hydraulic pump (10,000 psi) with standard 3/4" hydraulic quick coupler
- Supplied in steel storage case
- 3 x cranked legs
- 3 x straight legs
- 3 x leg extensions
- Spread 530mm
- Reach 760mm
- See page 139 for kit contents
- See page 136 for specifications

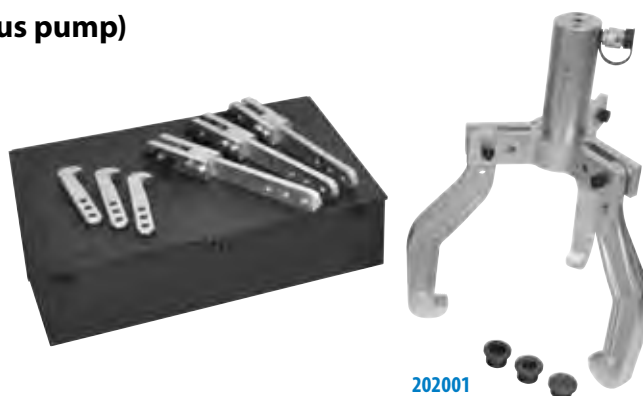

202020

20 Tonne Loadstar "Plus" Separator Add-On Pack

- Provides all additional components to add bearing separator capability to the entry level kit without any duplication of parts
- Supplied in steel storage case
- See page 139 for kit contents
- See page 136 for specifications



202030

20 Tonne Loadstar "Plus" Accessories Add-On Pack

- Provides a range of accessories which increase the capability of the entry level kit (with or without the Separator Add-On pack)
- Includes five extractor (pushing) pins for those hard to reach applications
- Auto-grip collar and adaptor for quick change of pins
- Ram bases and heads for jacking applications
- Supplied in steel storage case
- See page 139 for kit contents
- See page 136 for specifications



LOADSTAR HEAVY DUTY

20 TONNE - Loadstar "Plus" cont.

202040

20 Tonne Loadstar "Plus" Press Frame Add-On Pack

- Press frame assembly to add portable press capability
- Particularly useful for removal of HGV suspension king pins
- Includes five extractor (pushing) pins for those hard to reach applications
- Auto grip collar and adaptor for quick change of pins
- Supplied in steel storage case
- See page 139 for kit contents
- See page 136 for specifications and hydraulic pump assembly spare parts

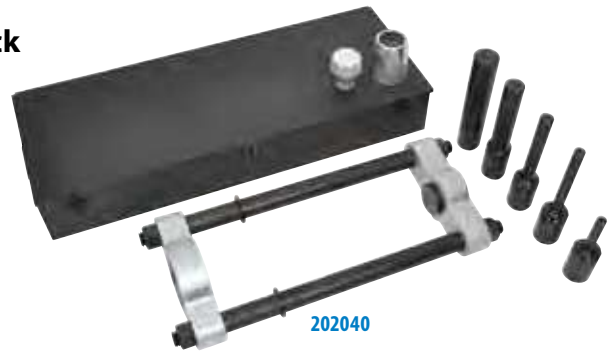

202040

202045

20 Tonne Loadstar "Plus" Puller/Separator Kit

- 20 tonne hydraulic cylinder and pump
- Contains full capability without any duplication of parts
- Four pulling combinations
- Bearing separator capability
- Supplied in steel storage case
- 3 x cranked legs
- 3 x straight legs
- 3 x leg extensions
- Spread 530mm
- Reach 760mm
- See page 139 for kit contents
- See page 136 for specifications and hydraulic pump assembly spare parts



202045

212000

20 Tonne Loadstar "Plus" Press Frame - Complete Kit

- 20 tonne hydraulic cylinder and pump
- Standalone portable press frame kit for pin pushing applications
- Particularly useful for removal of HGV suspension king pins
- Includes 5 extractor (pushing) pins for those hard to reach applications
- Auto grip collar and adaptor for quick change of pins
- Supplied in steel storage case
- See page 139 for kit contents
- See page 136 for specifications and hydraulic pump assembly spare parts



212000

212001

20 Tonne Loadstar "Plus" Press Frame - Complete Kit (minus pump)

- 20 tonne hydraulic cylinder
- Capability as above for those customers who already have a suitable hydraulic pump(10,000 psi) with standard 3/4" hydraulic quick coupler
- Supplied in steel storage case
- See page 139 for kit contents
- See page 136 for specifications

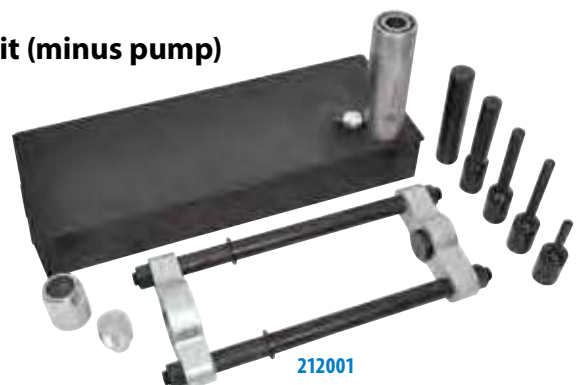

212001

LOADSTAR HEAVY DUTY

202050

20 Tonne Loadstar "Plus" Master Kit

- 20 tonne hydraulic cylinder and pump
- Contains full capability without any duplication of parts
- Four pulling combinations
- Bearing separator capability
- Portable press frame included
- Internal pulling unit included
- Supplied in two steel storage cases
- 3 x cranked legs
- 3 x straight legs
- 3 x leg extensions
- Spread 530mm
- Reach 760mm
- See below for kit contents
- See page 136 for specifications and hydraulic pump assembly spare parts

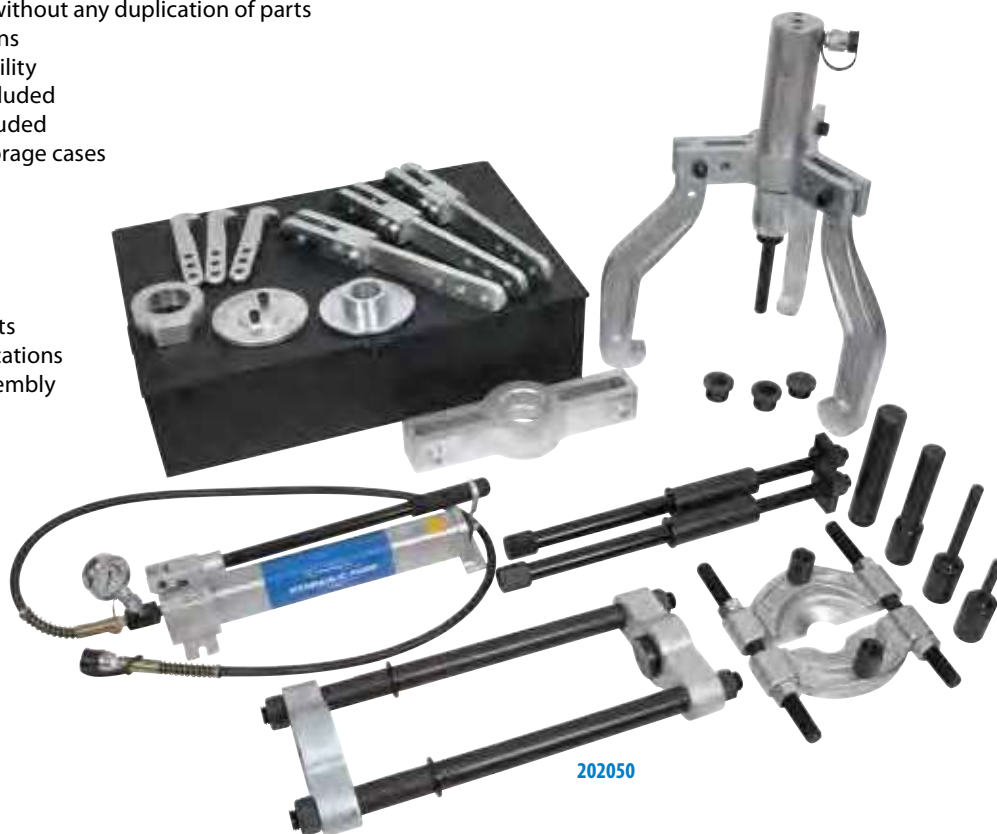

202050

Loadstar "Plus" 20 Tonne Kit Contents

Part No.	Description	Kit Part No.								
		202050	202000	202001	202020	202030	202040	202045	212000	212001
200170	Hydraulic Pump	1	1	-	-	-	-	1	1	-
200120	20T Hydraulic Cylinder	1	1	1	-	-	-	1	1	1
200285	20T 3 Way Beam incl. Pins & Nuts	1	1	1	-	-	-	1	-	-
200286	Puller Leg - Cranked	3	3	3	-	-	-	3	-	-
200284	Puller Leg - Straight	3	3	3	-	-	-	3	-	-
200192	Leg Extension incl Pins & Nuts	3	3	3	-	-	-	3	-	-
095300	Separator incl. Adaptors	1	-	-	1	-	-	1	-	-
200283	Twin Beam	1	-	-	1	-	-	1	-	-
200289	Rod Assembly	2	-	-	2	-	-	2	-	-
200124	Base Pushing Plate incl. Bolts	1	-	-	-	1	-	-	-	-
200121	Base	1	-	-	-	1	-	-	-	-
200123	Toe Lift Finished	1	-	-	-	1	-	-	-	-
200144	Extractor Pin 25 x 150	1	-	-	-	1	1	-	1	1
200145	Extractor Pin 50 x 150	1	-	-	-	1	1	-	1	1
200146	Extractor Pin 38 x 150	1	-	-	-	1	1	-	1	1
200147	Extractor Pin 18 x 75	1	-	-	-	1	1	-	1	1
200148	Extractor Pin 20 x 150	1	-	-	-	1	1	-	1	1
200149	Auto Grip Collar & Adaptor	1	-	-	-	1	1	-	1	1
200395	Press Frame	1	-	-	-	-	1	-	1	1
202083	Steel Storage Case	2	1	1	-	-	-	-	-	-
202084	Steel Storage Case	-	-	-	1	-	1	-	1	1
080382	Steel Storage Case	-	-	-	-	1	-	-	-	-

LOADSTAR HEAVY DUTY

30 TONNE - Loadstar "Plus"

203000

30 Tonne Loadstar "Plus" Entry Level Kit

- 30 tonne hydraulic cylinder and pump
- Four pulling combinations
- Supplied in steel storage case
- 3 x cranked legs
- 3 x straight legs
- 3 x leg extensions
- Spread 530mm
- Reach 580mm
- See page 141 for kit contents
- See page 136 for specifications and hydraulic pump assembly spare parts



203000

203001

30 Tonne Loadstar "Plus" Entry Level Kit (minus pump)

- 30 tonne hydraulic cylinder
- Capability as above for those customers who already have a suitable hydraulic pump (10,000 psi) with standard 3/4" hydraulic quick coupler
- Supplied in steel storage case
- Spread 530mm
- Reach 580mm
- See page 141 for kit contents
- See page 136 for specifications



203001

203020

30 Tonne Loadstar "Plus" Separator Add-On Pack

- Provides all additional components to add bearing capability to the entry level kit without any duplication of parts
- Supplied in steel storage case
- See page 141 for kit contents
- See page 136 for specifications



203020

LOADSTAR HEAVY DUTY

203050

30 Tonne Loadstar "Plus" Master Kit

- 30 tonne hydraulic cylinder and pump
- Contains full capability without any duplication of parts
- Four pulling combinations
- Bearing separator capability
- Internal pulling unit included
- Supplied in two steel storage case
- 3 x cranked legs
- 3 x straight legs
- 3 x leg extensions
- Spread 530mm
- Reach 580mm
- See below for kit contents
- See page 136 for specifications and hydraulic pump assembly spare parts



203050

Loadstar "Plus" 30 Tonne Kit Contents

Part No.	Description	Kit Part No.			
		203050	203000	203001	203020
200170	Hydraulic Pump	1	1	-	-
200130	30T Hydraulic Cylinder	1	1	1	-
200384	30T Triple Beam incl Pins & Bolts	1	1	1	-
200286	Puller Leg – Cranked	3	3	3	-
200284	Puller Leg – Straight	3	3	3	-
200192	Leg Extension incl. Pins & Nuts	3	3	3	-
200131	Adjusting Screw	1	1	1	-
200132	Handle	1	1	1	-
200135	Rod End Cap	1	1	1	-
200481	M10 x 1.5 x 75mm Long Bolt	2	2	2	-
095300	Separator incl Adaptors	1	-	-	1
200584	Twin Beam	1	-	-	1
200289	Rod Assembly	2	-	-	2
200290	Extension Rod	2	-	-	2
200595	Internal Pulling Unit	1	-	-	-
300250	Connector	2	-	-	2
202083	Steel Storage Case	1	1	1	-
202084	Steel Storage Case	1	-	-	1

LOADSTAR HEAVY DUTY

50 TONNE - Loadstar "Plus"

205000

50 Tonne Loadstar "Plus" Entry Level Kit

- 50 tonne hydraulic cylinder and pump
- Four pulling combinations
- Supplied in steel storage case
- 3 x cranked legs
- 3 x straight legs
- 3 x leg extensions
- Spread 530mm
- Reach 470mm
- See page 143 for kit contents
- See page 136 for specifications and hydraulic pump assembly spare parts



205000

205001

50 Tonne Loadstar "Plus" Entry Level Kit (minus pump)

- 50 tonne hydraulic cylinder
- Capability as above for those customers who already have a suitable hydraulic pump (10,000 psi) with standard 3/4" hydraulic quick coupler
- Supplied in steel storage case
- Spread 530mm
- Reach 470mm
- See page 143 for kit contents
- See page 136 for specifications



205001

205020

50 Tonne Loadstar "Plus" Separator Add-On Pack

- Provides all additional components to add bearing separator capability to the entry level kit without any duplication of parts
- Supplied in steel storage case
- See page 143 for kit contents
- See page 136 for specifications



205020

LOADSTAR HEAVY DUTY

205050

50 Tonne Loadstar "Plus" Comprehensive Kit

- 50 tonne hydraulic cylinder and pump
- Contains full capability without any duplication of parts
- Four pulling combinations
- Bearing separator capability
- Internal pulling unit included
- Supplied in two steel storage cases
- 3 x cranked legs
- 3 x straight legs
- 3 x leg extensions
- Spread 530mm
- Reach 470mm
- See below for kit contents
- See page 136 for specifications and hydraulic pump assembly spare parts



205050

Loadstar "Plus" 50 Tonne Kit Contents

Part No.	Description	Kit Part No.			
		205050	205000	205001	205020
200170	Hydraulic Pump	1	1	-	-
200150	50T Hydraulic Cylinder	1	1	1	-
200682	50T Triple beam incl Pins, Nuts & Bolts	1	1	1	-
200286	Puller Leg - Cranked	3	3	3	-
200284	Puller Leg - Straight	3	3	3	-
200192	Leg Extension incl. Pins & Nuts	3	3	3	-
200151	Adjusting Screw	1	1	1	-
200152	Handle	1	1	1	-
200155	Adjusting Screw cap ADZ 60	1	1	1	-
095300	Separators incl Adaptors	1	-	-	1
200685	Twin Beam incl Bolts	1	-	-	1
200289	Rod Assembly	2	-	-	2
200290	Extension Rod	2	-	-	2
200595	Internal Pulling Unit	1	-	-	-
300250	Connector	2	-	-	2
202083	Steel Storage Case	1	1	1	-
202084	Steel Storage Case	1	-	-	1

SLIDE HAMMER PULLERS



Slide Hammer Pullers

- A pulling system that offers versatility with many different puller combinations
- The system covers a wide range of automotive, industrial and engineering applications for bearings, gears, oil seals, bearing outer races and pinions
- The slide hammer allows the tool to be used where a conventional screw puller is not suitable due to the absence of a shaft

COMBI PULL - Slide Hammer Pullers

085400

Slide Hammer Puller Kit - Combi Pull

- 3 straight legs, 3 cranked reversible legs for internal and external pulling
- Adjustable cone ensures positive location, minimising risk of slippage
- Supplied in metal case
- Refer to pages 176-177 for component illustrations

Specifications

Part No.	Leg Style	External Spread Min - Max mm	Internal Spread Min - Max mm	External Reach Max mm
085400	Straight	66 - 105	23 - 83	75
	Cranked	66 - 105	33 - 70	65

Contents

Part No.	Qty	Description
085412	1	Twin Beam
085413	1	Triple Beam
085414	3	Leg - Large
085415	3	Leg - Small Cranked
085421	1	Slide Hammer Assembly 1kg
085418	1	Cone

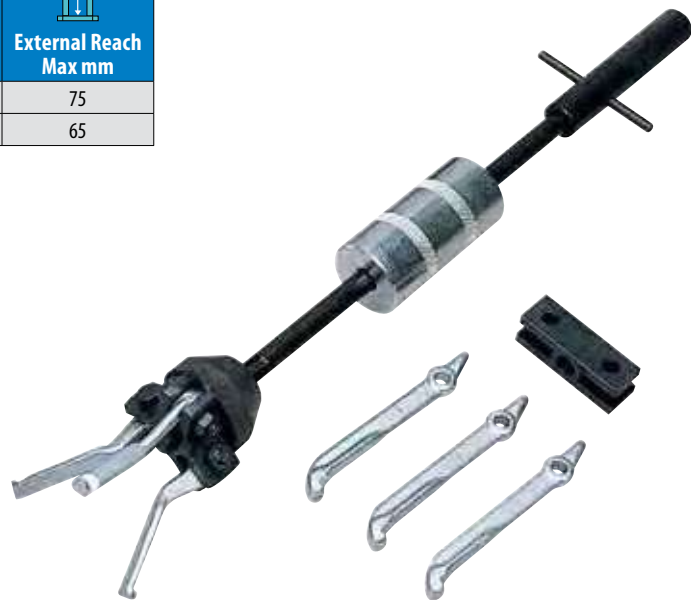

085400

SLIDE HAMMER PULLERS

085450

Slide Hammer Puller Kit - Combi Pull

- 16 different puller combinations and slide hammer operation
- Force screw operation produces 1 tonne pressure
- 3 straight legs, 3 cranked reversible legs
- Internal/external
- Includes 'T' bar and screw for manual operation
- Supplied in metal case
- Refer to pages 176-177 for component illustrations



085450

Specifications

Part No.	Leg Style	External Spread Min - Max mm	Internal Spread Min - Max mm	External Reach Max mm
085450	Straight	66 - 105	23 - 83	75
	Cranked	66 - 105	33 - 70	65

Contents

Part No.	Qty	Description	Part No.	Qty	Description
082103	1	Forcing Screw	08545270	1	Adaptor Nut
082104	1	Extension Piece	085453	1	Cone
085414	3	Leg - Large	085454	1	Twin Beam
085415	3	Leg - Small Cranked	085455	1	Triple Beam
085421	1	Slide Hammer Assembly 1kg			

085403

Slide Hammer Puller Kit - Combi Pull & Split Collet Extractor

- 3 straight legs, 3 cranked reversible legs for internal and external pulling
- 4 split collet internal extractors
- Adjustable cone ensures positive location, minimising risk of slippage
- Supplied in carton
- Refer to pages 176-177 for component illustrations

Specifications

Part No.	Leg Style	External Spread Min - Max mm	Internal Spread Min - Max mm	External Reach Max mm
085403	Straight	66 - 105	23 - 83	75
	Cranked	66 - 105	33 - 70	65
	Split Collets	-	10.5 - 30	-

Contents

Part No.	Qty	Description
085400	1	Slide Hammer Puller Set
095811	1	Split Collet Extractor 10.5-13mm
095812	1	Split Collet Extractor 13-18mm
095813	1	Split Collet Extractor 18-22.5mm
095814	1	Split Collet Extractor 22.5-30mm
095820	1	Adaptor



085403



SLIDE HAMMER PULLERS

SPLIT COLLET EXTRACTOR PULLERS

Internal Extractor Kits

- Extract components quickly and efficiently when conventional pullers cannot be used
- Removes bearings, oil seals etc
- Twin beam pulling unit attachment available **095805**
- Refer to pages 176-177 for component illustrations

Specifications

 Part No.	 Internal Spread Min - Max mm	No. of Split Collet Extractors	Upgrade
095801	6 - 13	3	Twin Beam Pulling Unit p/n 095805
095802	13 - 30	3	
095803	30 - 60	3	
095804	8 - 22.5	4	

Contents

Description	Qty	Kit Part No.				
		095801	095802	095803	095804	
Slide Hammer Assembly 1kg	1	085421	085421	085421	085421	
Split Collet Extractor	Extractor 6-8.5mm	1	095809	-	-	-
	Extractor 8-11mm	1	095810	-	-	095810
	Extractor 10.5-13mm	1	095811	-	-	095811
	Extractor 13-18mm	1	-	095812	-	095812
	Extractor 18-22.5mm	1	-	095813	-	095813
	Extractor 22.5-30mm	1	-	095814	-	-
	Extractor 30-38mm	1	-	-	095815	-
	Extractor 38-50mm	1	-	-	095816	-
	Extractor 50-60mm	1	-	-	095817	-
Adaptor	1	095820	095820	-	095820	

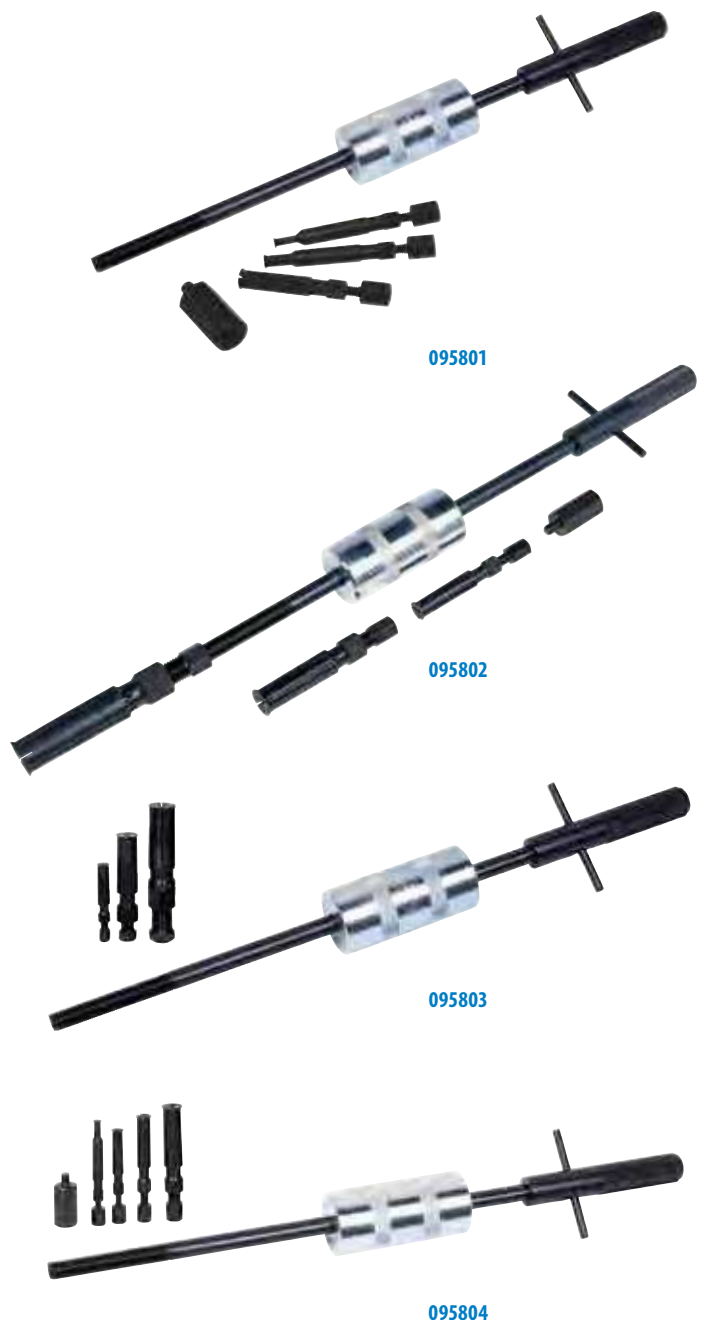

SLIDE HAMMER PULLERS

095800

Internal Split Collets Extractor Kit

- Extract components quickly and efficiently when conventional pullers cannot be used
- Removes gears, bearings, pinions, oil seals etc
- Can be upgraded for twin/triple leg pulling
- Supplied in metal case
- Refer to pages 176-177 for component illustrations

Specifications

Part No.	Internal Spread Min - Max mm	Twin Beam Pulling Unit 095805	No. of Split Collet Extractors
095800	6 - 60	Included	9

Contents

Spare Parts Part No.	Qty	Description
085421	1	Slide Hammer Assembly
095805	1	Pulling Unit
095809	1	Split Collet Extractor 6-8.5mm
095810	1	Split Collet Extractor 8-11mm
095811	1	Split Collet Extractor 10.5-13mm
095812	1	Split Collet Extractor 13-18mm
095813	1	Split Collet Extractor 18-22.5mm
095814	1	Split Collet Extractor 22.5-30mm
095815	1	Split Collet Extractor 30-38mm
095816	1	Split Collet Extractor 38-50mm
095817	1	Split Collet Extractor 50-60mm
095820	1	Adaptor



095805

Twin Beam Pulling Unit

- Twin beam mechanical puller for use with Sykes-Pickavant split collet type internal extractors
- Mechanical force screw can then be used to draw extractors in place of slide hammer





PULLERS AND BEARING SEPARATORS

EXTERNAL BEARING PULLERS

- With tapered edge for insertion behind close fitting bearings, gears etc
- Drop forged, high quality alloy steel, heat treated for strength and durability
- Can be upgraded for internal pulling by adding internal pulling attachments **093500** or **093600**, see page 149
- Users should also use correct thread protector to fit bearing puller, see page 149
- Each kit supplied in metal case
- Refer to pages 177 for component illustrations

Specifications

 Part No.	 Internal Spread Min - Max mm	 External Reach Max mm	Upgrade
093000	0 - 55	115	-
093100	20 - 105	876	093500
093200	35 - 140	860	
093300	50 - 175	760	093600

Contents

Description	Qty	Kit Part No.			
		093000	093100	093200	093300
Beam	1	093012	093112	093212	093312
Screw/thrust nut	1	082811	093111	093211	093311
Thrust race	1	-	093121	093221	093321
Main rods, nuts & washers	2	093015	093115	093215	093315
5" Extension rods	2	-	093123	093223	-
Extension rods	4	-	093119	093219	093319
Separator	1	095000	095100	095200	095300

Pulling units without bearing separator are available. They contain twin beam, screw, thrust nut, thrust race and main rod assembly can be supplied if required.

These are related to kits described above as follows;

Kit No. 093000 = Pulling Unit No. 094000

Kit No. 093100 = Pulling Unit No. 094100

Kit No. 093200 = Pulling Unit No. 094200

Kit No. 093300 = Pulling Unit No. 094300





094500

Mechanical Internal Extractor Kit

- For the extraction of bushes, sleeves and bearings from blind housings, when the centre shaft has been removed and does not allow the use of a mechanical puller
- Supplied in carton
- Refer to pages 177 for component illustrations

Specifications

 Part No.	 Internal Spread Min - Max mm	 External Reach Max mm
094500	40 - 150	100





PULLERS AND BEARING SEPARATORS

Internal Pulling Attachments

- Pulling attachment for Sykes-Pickavant bearing pullers
- Users should also use correct thread protector to fit their bearing puller
- Supplied in carton

Specifications

 Part No.	 Internal Spread Min - Max mm	 External Reach Max mm	Use with	Use screw adaptor
093500	40 - 150	100	093100 Kit*	none required
			093200 Kit*	093501
093600	75 - 230	150	093300 Kit*	093601



*Thread Protectors

When ordering an internal pulling attachment users should also order the correct thread protectors to fit their pulling unit or bearing puller kit.

Pulling Unit Part No. 094100 Pulling Kit Part No. 093100	Use Thread Protectors Part No. 093120 (2)
Pulling Unit Part No. 094200 Pulling Kit Part No. 093200	Use Thread Protectors Part No. 093220 (2)
Pulling Unit Part No. 094300 Pulling Kit Part No. 093300	Use Thread Protectors Part No. 093320 (2)





BEARING SEPARATORS

- Individual separators for removing and refitting bearings, etc
- Can be used with any of the Sykes-Pickavant design of pullers where standard legs cannot gain access
- Tapered legs provide all round support
- Supplied in carton



Specifications

 Part No.	 Internal Spread Min - Max mm	Use with
095000	10 - 55	Can be used with 083000 Twin Leg Puller or 094000 Twin Leg Pulling Unit
095100	20 - 105	Use with 083100 Twin Leg Puller or 094100 Twin Leg Pulling Unit
095200	35 - 140	Can be used with 083200 And 083300 Twin Leg Pullers or 094200 Twin Leg Pulling Unit
095300	50 - 175	Can be used with Sykes-Pickavant 'Loadstar' Heavy Duty Pullers or 094300 Twin Leg Pulling Unit



PULLERS AND BEARING SEPARATORS

MULTIPULL® BLIND HOUSING BEARING REMOVERS

- These special pullers will remove blind housing bearings without the need to dismantle machinery or remove the running shaft
- Positive seating allows even tension on inner and outer bearing rings, reducing resistance
- Stabilisers reduce sideways movement and self-centre the puller
- Three kits cover a wide range of ISO bearings. (To identify kit for bearings without an ISO reference, refer to puller spread and adaptor diameter)
- Supplied in blow mould case
- Refer to page 178 for component illustrations

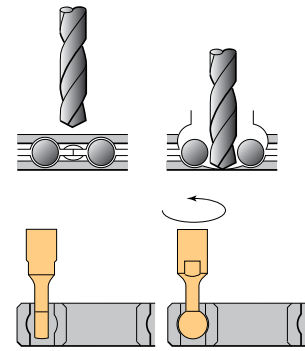

Specifications

Part No.	Min Spread mm	Max Spread mm	Adaptor Dia. mm	Puller Reach mm	ISO Bearing Designation			
					6004 - 6010	6299 - 6205	6300 - 6302	–
098000	20	95	5.5 - 8	125	6004 - 6010	6299 - 6205	6300 - 6302	–
098100	20	117	5.5 - 12.5	415	6004 - 6015	6200 - 6211	6300 - 6307	6403 - 6404
098200	56	210	16 - 31.75	490	–	6212 - 6222	6308 - 6319	6405 - 6414

Contents

Description	Qty	Kit Part No.			Description	Qty	Kit Part No.			
		098000	098100	098200			098000	098100	098200	
Beam	1	098012	098012	098212	Bearing Adaptors	No.1	2	098021 (5.5mm)	098021 (5.5mm)	–
	1	–	098112	–		No.2	2	098022 (6mm)	098022 (6mm)	–
Screw	1	098011	098011	093113		No.3	2	098023 (8mm)	098023 (8mm)	–
	1	–	082811	–		No.4	2	–	098124 (9mm)	–
Thrust Nut	1	–	–	098214		No.5	2	–	098125 (11mm)	–
Thrust Washer	1	–	–	098213		No.6	2	–	098126 (12.5mm)	–
Rod Assembly	2	098015	098015	098215		No.7	2	–	–	098227 (16mm)
	2	–	098115	–		No.8	2	–	–	098228 (19mm)
Rod Extensions	2	098017 (95mm)	098017 (95mm)	098217 (195mm)		No.9	2	–	–	098229 (22mm)
	2	098019 (30mm)	098019 (30mm)	098218 (295mm)		No.10	2	–	–	098230 (25mm)
	2	–	098119 (95mm)	–		No.11	2	–	–	098231 (28mm)
	2	–	098120 (195mm)	–		No.12	2	–	–	098232 (31.75mm)



098000



098100



098200

HUB AND STUD PULLERS

ADJUSTABLE HUB PULLERS - Car, LCV

- Comprehensive range of mechanical and hydraulic hub pullers to suit passenger and light commercial vehicles
- Manufactured with free moving legs mounted on a floating plunger enables quick and easy attachment to vehicle hubs
- 3 or 5 leg configurations provide up to 203mm of spread with a hole size suitable for studs up to 15.8mm in diameter
- Available as a combined kit or with a choice of:
 - Heavy duty hammer type handle for shock force use, or
 - 1500 series hydraulic ram for smooth, progressive force up to 8 tonnes
- All configurations feature a fine pitch outer thread for micro adjustment
- Manufactured from heat treated, drop forged steel
- Option to add additional legs



Contents

Part No.	Description	Length (mm)	Kit Part No.				
			Mechanical		Hydraulic		Mechanical & Hydraulic
			082503	082505	127303	127305	127306
082514	Leg	158	3	5	3	5	5
127311	Force Screw	285	1	1	-	-	1
082519	Shock Handle	203	1	1	-	-	1
127312	Plunger Body	100 Dia.	1	1	1	1	1
150000	Hydraulic Ram	-	-	-	1	1	1
152422	Ram Extension	50	-	-	1	1	1



082503



082505



127303



127306

ADJUSTABLE HUB PULLERS - Commercial Vehicles

- Specially designed free moving legs provide up to 305mm of spread with hole size suitable for studs up to 22mm in diameter
 - Heavy duty hammer type handle with fine pitch force screw allows for use of shock force for tight and troublesome applications
 - Manufactured from heat treated, drop forged steel
 - Available in 3 and 6 leg configurations
 - Option to add additional legs or upgrade to hydraulic style
- 082214** Leg (1)
150000 1500 Series Hydraulic Ram
152422 Ram Extension (50mm)



082203



082206

Contents

Part No.	Description	Length (mm)	Kit Part No.	
			082203	082206
082214	Leg	211	3	6
127311	Force Screw	285	1	1
082519	Shock Handle	203	1	1
082212	Plunger Body	152 Dia.	1	1

HUB AND STUD PULLERS

FIXED PLATE HUB PULLER KITS - Car, LCV

- Fix plate hub puller for cars and light commercials, featuring **085308** Hub Puller Plate which has been specially designed to meet the application requirements of modern vehicles
- Features a specially enlarged central dome to accommodate larger wheel hub caps (eg. Ford Focus) as found on many modern vehicles
- Designed with an extended spread pattern, to accommodate up to 160mm stud circle diameters
- Available in three configurations depending on the user requirements
 - Mechanical with converter and forcing screw
 - Hydraulic with 1500 series 8 tonne hydraulic ram
 - Slide hammer with converter and 1.6kg slide hammer unit
- Option to add additional components



085300
Mechanical
Puller

Specifications – Hub Puller Plate

Hub Centre Diameter	70mm
Hub Centre Depth	65mm
Min. Pitch Circle Diameter	100mm
Max. Pitch Circle Diameter	160mm
Centre Hole Screw Thread	1 1/2" x 16 Tpi



085308



085316
Hydraulic
Puller



085306
Slide Hammer
Hub Puller

Contents

Part No.	Description	Specification	Kit Part No.		
			Mechanical	Hydraulic	Slide Hammer
085308	Hub Puller Plate	See table below	1	1	1
085312	Hub Puller Plate Mechanical Converter	1 1/2" x 16 Tpi (Ext. Thread) 5/8" UNF (Int. Thread)	1	-	1
085311	Mechanical Forcing Screw	5/8" UNF x 4" 24mm Hex Drive	1	-	-
085307	Slide Hammer	5/8" UNF, 1.6kg	-	-	1
150000	Hydraulic Ram	8 Tonne force	-	1	-

050500

Impact Pitman/Drop Arm Puller

- Heavy duty puller for the removal of Pitman/drop arms from the toughest of vehicle applications
- Suits Land Rover Discovery 1 & 2, Range Rover P38, Land Rover Defender and Ford Transit
- The puller is designed to be used with the steering box already removed from the vehicle
- Includes an impact force screw allowing the technician to effectively shock the Pitman/drop arm loose from the steering box
- Spare Parts:
 - 127311** Impact Forcing Screw
 - 082519** Shock Handle



Puller Spread Max (mm)	Puller Reach Max (mm)
60	80

HUB AND STUD PULLERS

085309

Slide Hammer Assembly - 4.5kg

- Can be used with the full range of Sykes-Pickavant hub pullers to remove hubs and half shafts quickly and efficiently

Specifications

Description	Length mm	Stud Hole Diameter	Thread	Hammer Weight
Hammer	165	100		4.5kg
Shaft	838	–	M20 x 2.5	–
Adaptor	40	–	M20 (int.), 1 1/2 whit (ext.)	–

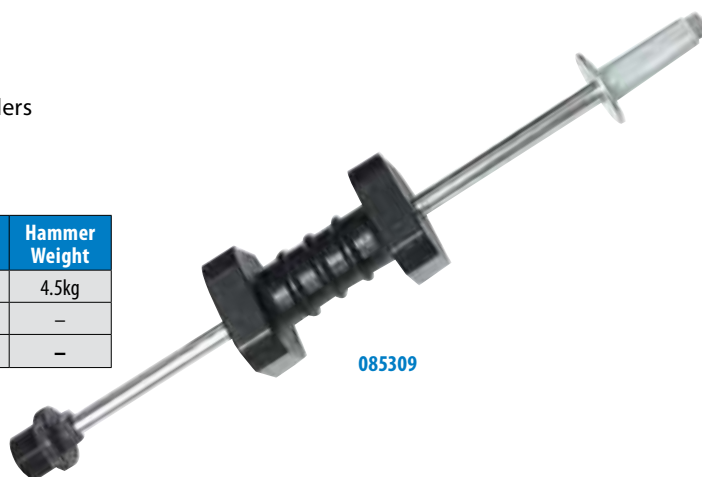

085309

TRUCK AND HGV

Hydraulic Truck Wheel and Hub Puller

- This unique wheel and hub removal solution has been specifically developed for the truck servicing and repair industry
- 12 Tonne hydraulic pump with a series of unique chains and attachments provide the ability to remove truck wheels and hubs which have become seized over time due to road grime and general operation
- Supplied in a durable metal case for convenient storage or secure transportation. The metal case can be fixed to the mobile trolley attachment which is ideal for rapid workshop use
- Available in three configurations to cater for varying customer requirements, repair centres and mobile workshops
- **See next page for more information**



Contents

Part No.	Description	Kit Part No.		
		Wheel Puller	Wheel Puller with Trolley	Combined Wheel & Hub Puller
		08700	208750	208795
208710	12T Hydraulic Pump	1	1	1
208711	Locking Ring	1	1	1
208712	Flame Cut Beam	1	1	1
208713	Chains with Clevis Pins	4	4	4
208714	Chain Connecting Pin	2	2	2
208715	R Clips	8	8	8
208716	Hook - Steel Rim Inner	4	4	4
208717	Hook - Steel Rim Outer	4	4	4
208722	Hook - Aluminium Rim Outer	4	4	4
208724	Hook - Aluminium Rim Inner	4	4	4
208718	Pusher Cage Top Plate	1	1	1
208719	Pusher Ring Large	1	1	1
208720	Connecting Rods	4	4	4
208723	Spigot Bung Assembly	1	1	1
208721	Pusher Ring Small	1	1	1
208782	Metal Box	1	1	1
208730	Mobile Trolley Attachment	Option	1	1
208725	Hub Puller - Hooks			4
208726	Hub Puller - Nose Piece		Option 208760	1
208727	Hub Puller - Nose Piece Extension- 2 Piece		Hub Puller Add-on Kit	1
208728	Hub Puller - Chains with Clevis Pins (7 Link)			4

HUB AND STUD PULLERS

TRUCK AND HGV cont.

Wheel Pulling

- Designed for the removal of ten stud 22.5" HGV wheels and associated axle hubs
- Suitable for pulling inner and outer wheels on twin or single wheel hubs
- Equal load distribution is achieved via four high strength chains allowing 2, 3 or 4 point pulling
- Hook system incorporates four hook types designed for internal and external pulling applications
- Plastic coated hook set provides protection for use on alloy and polished wheels
- Centre spigot frame assembly features two ring sizes and covers most popular applications
 - 281mm centre hole diameter
 - 221mm centre hole diameter
- Locates on the spigot lugs on the hub or can push against hub cover bolt heads
- Reversible beam to provide extra adjustment



Hub Pulling

- Contains a set of four shorter chains for close proximity to hub
- Four eyelet hooks designed specifically to attach to the hub wheel studs
- Ram nose piece applies force to the end of stub axle
- Two nose extension pieces to suit various hub configurations



208760 Hub Puller Add-on Kit

Mobile Trolley 208730

- Enables rapid workshop use
- Provides additional support during wheel or hub removal
- Storage case mounts for secure storage and transportation



Pusher Cage and Ring



Aluminium Rim - Hooks



Steel Rim - Hooks



Hub Puller - Hooks

PULLER BOARDS



Puller Boards

- Heavy duty display boards for convenient storage of pullers
- Suitable for wall mounting in any service bay, maintenance workshop or store
- Start with the basic kit then add with upgrade boards
- Keeps tools tidy and accessible, see when components are missing
- Powder coated backing board with vinyl overlay and shadows
- All boards 610 x 457mm except part number 155400

096500

Combi-Puller Kit

- 5 and 10 tonne capacity pulling solution
- Four different leg shapes to cover wide application
- Graduated beam for accurate leg positioning
- Legs can be bolted together to extend reach
- Latest design includes part number and description on shadow board for easy product identification

Specifications

Part No.	Capacity Tonne	Kit Style	Spread Min - Max mm	Reach Max mm
096500	5	Twin	10 - 173	140
		Triple	10 - 173	140
	10	Twin	20 - 250	182
		Triple	20 - 250	182

Contents

Part No.	Qty	Description
096011	1	5T Force Screw
096013	1	5T Triple Head
096053	3	5T Narrow Leg - Long
096054	3	5T Slotted Leg - Short
096055	3	5T Thin Jaw Leg - Short
096056	3	5T Thin Jaw Leg - Long
096016	1	5T Leg Clips - Set of 4
096014	3	5T Connecting Bolt Assembly
096111	1	10T Force Screw
096113	1	10T Triple Head
096153	3	10T Narrow Leg - Long
096154	3	10T Slotted Leg - Short
096155	3	10T Thin Jaw Leg - Short
096156	3	10T Thin Jaw Leg - Long
096116	1	10T Leg Clips - Set of 4
096114	3	10T Connecting Bolt Assembly
096012	1	5T Twin Head
096112	1	10T Twin Head



096500

PULLER BOARDS

084907

Mechanical Twin/Triple Puller - 4", 6", 8"

- Twin and triple beams and double ended legs for a wide range of pulling options
- For removing gears, races, bearings and sprockets
- Automotive and industrial applications
- Drop forged steel legs, beam and jaws
- Heat treated for strength and durability
- Latest design includes part number and description on shadow board for easy product identification

Specifications

Part No.	Spread Min - Max mm	Reach Max mm	No. of Puller Combinations	Leg Style
084907	0 - 300	250	12	Standard adjustable/ Double ended reversible

Contents

Part No.	Qty	Description
083000	1	Twin Leg Puller - Reversible
083100	1	Twin Leg Puller - Reversible
083200	1	Twin Leg Puller - Std Adjustable
082714	1	Leg Assembly - Reversible
082814	1	Leg Assembly - Reversible
082914	1	Leg Assembly - Std Adjustable
660363	1	Triple Head
082813	1	Triple Head
082913	1	Triple Head



084907

086505

Mechanical Puller - Thin Jaw

- Contains components to make up 7 thin jaw leg pullers
- Thin jaws enable access where clearance behind components is limited
- On metal storage/display panel complete with hooks
- Also available in metal case **086504**, see page 116

Specifications

Part No.	Spread Max mm	Reach Max mm	No. of Puller Combinations	Leg Style
086505	184	225	7	Standard adjustable/ Double ended reversible

Contents

Part No.	Qty	Description
086111	1	Forcing Screw
082911	1	Forcing Screw
086000	1	Puller - Thin Jaw
086112	1	Twin Beam
086212	1	Twin Beam
086513	1	Triple Beam
086114	3	Leg 150mm - Thin Jaw
086214	3	Leg 225mm - Thin Jaw



086505

PULLER BOARDS

084905

Mechanical Combination Puller & Separator Kit

- Makes 9 mechanical 2 or 3 leg pullers and 1 separator
- On metal storage/display panel complete with hooks
- Thin jaws enable access where clearance behind component is limited
- Double ended legs for internal and external use

Specifications

Part No.	Spread Max mm	Reach Max mm	External Spread Max mm	No. of Puller Combinations	Leg Style
084905	140	200	55	9	Standard adjustable/ Double ended reversible/ Thin Jaw

Contents

Part No.	Qty	Description
082711	1	Forcing Screw
082811	1	Forcing Screw
660362	1	Twin Head
660363	1	Triple Head
082812	1	Twin Beam
082813	1	Triple Beam
082714	3	Leg Assembly - Reversible
082814	3	Leg Assembly - Reversible

Part No.	Qty	Description
095000	1	Separator 10-55mm
086014	2	Leg 75mm - Thin Jaw
093012	1	Twin Beam
093015	2	Main Rod



084905

186505

Hydraulic Twin/Triple Leg Puller Kit - Thin Jaw

- Makes 5 different hydraulic and 1 mechanical thin jaw puller
- Refer to pages 171-175 for component illustrations
- On metal storage/display panel complete with hooks
- Also available in metal case **186504**, see page 132

Specifications

Part No.	Puller Spread Min - Max mm	Puller Reach Max mm	Ram Extension mm	No. of Puller Combinations	Leg Style
186505	50 - 225	225	50 / 150	6	Thin Jaw

Contents

Part No.	Qty	Description
150000	1	Hydraulic Ram With Nose Piece
152422	1	Ram Extension - 50mm
152726	1	Ram Extension - 150mm
086012	1	Twin Beam
186212	1	Twin Beam
186513	1	Triple Beam
193112	1	Twin Beam
086014	2	Leg 75mm - Thin Jaw
086214	3	Leg 225mm - Thin Jaw
082711	1	Forcing Screw 12 X 1.75 X 150mm
086114	3	Leg 150mm - Thin Jaw



186505

PULLERS

PULLER BOARDS

155106

Hydraulic Twin/Triple Leg Puller Kit

- Removes gears, bearings, pulleys & sprockets
- Makes 3 different hydraulic twin/triple leg pullers
- Powered by 1500 series hydraulic ram
- 8 tonnes of force with minimum effort
- Latest design include part number and description on shadow board for easy product identification

Specifications

Part No.	Puller Spread Min - Max mm	Puller Reach Max mm	Ram Extension mm	No. of Puller Combinations	Leg Style
155106	75 - 150	150	50 / 100	3	Standard

Contents

Part No.	Qty	Description
150000	1	Hydraulic Ram with Nose Piece
152422	1	Ram Extension 50mm
152624	1	Ram Extension 100mm
152412	1	Twin Head
153413	1	Triple Head
152424	3	Standard Leg 100mm
152626	3	Standard Leg 150mm



155106

155107

Hydraulic/Mechanical Twin/Triple Puller - Upgrade

- Combined with hydraulic puller board (155106) makes 8 different twin/triple leg pullers
- Larger size legs included to increase capacity
- Forcing screw with shock handle included so can be used without hydraulic ram - converts hydraulic beams to mechanical style pullers
- Latest design include part number and description on shadow board for easy product identification

Specifications

Part No.	Puller Spread Min - Max mm	Puller Reach Max mm	Ram Extension mm	Leg Style
155107	50 - 250	250	50 / 100 / 150	Standard

Contents

Part No.	Qty	Description
152726	1	Ram Extension 150mm
152828	3	Leg 200mm
152929	3	Leg 250mm (Extra wide)
127311	1	Forcing Screw 285mm -1.5" x 16 BSW
082519	1	Shock Handle 203mm -1.5" x 16 BSW







155107

155108

Separator/Internal Race Extractor/Press Frame

- Individual separator included for removing and refitting bearings, etc
- Can be used with any of the Sykes-Pickavant design of pullers where standard legs cannot gain access
- Tapered legs provide all round support
- Includes pulling attachment for Sykes-Pickavant bearing pullers for the extraction of bushes, sleeves and bearings when the centre shaft has been removed and does not allow the use of a mechanical puller
- Latest design include part number and description on shadow board for easy product identification

Specifications

			
Part No.	External Spread Min - Max mm	Internal Spread Min - Max mm	External Reach Max mm
155108	20-105	40 - 150	876

Contents

Part No.	Qty	Description
095100	1	Separator 20-105mm
093500	1	Internal Race Extractor
193112	1	Twin Beam
093111	1	Screw with Nut
093115	2	Main Rod 254mm

Part No.	Qty	Description
093123	2	Extension Rod 127mm
093119	4	Extension Rod 285mm



155108

155405







Hydraulic Puller & Separator Kit

- Versatile tool where a long reach is required to draw a bearing from a shaft
- Tapered edges of bearing separator provide all round support and can fit behind bearings where normal puller legs cannot gain access
- Refer to pages 171-175 for component illustrations
- On metal storage/display panel complete with hooks
- Also available in metal case **155400**, see page 127



155405

Specifications

					
Part No.	Puller Spread Min - Max mm	Puller Reach Max mm	Ram Extension mm	External Spread Max mm	Leg Style
155405	50 - 200	200	20 - 105	876	Standard

Contents

Part No.	Qty	Description
150000	1	Hydraulic Ram With Nose Piece
152412	1	Twin Head
153413	1	Triple Head
152422	1	Ram Extension - 50mm
152624	1	Ram Extension - 100mm
152726	1	Ram Extension - 150mm
152424	3	Leg - 100mm
152626	3	Leg - 150mm

Part No.	Qty	Description
152828	3	Leg - 200mm
152727	3	Leg - 250mm
152929	3	Leg - 250mm (Extra Wide)
193112	1	Twin Beam
095100	1	Separator 20-105mm
093115	2	Main Rod
093119	4	Extension Rod
093123	2	Extension Rod 5 inch

PULLER BOARDS

193106

Slide Hammer/Split Collet Extractor

- 3 straight legs, 3 cranked reversible legs and 6 split collet extractors for internal and external pulling
- Adjustable cone ensures positive location minimising risk of slippage
- The split collet is pushed into the centre of the bearing and then expanded via the hex nut on the end of the collet until a secure grip is achieved
- The slide hammer is then attached providing the necessary extracting force
- Latest design include part number and description on shadow board for easy product identification

Slide Hammer Specifications

Part No.	Leg Style	External Spread Min - Max mm	Internal Spread Min - Max mm	External Reach Max mm
193106	Straight	66 - 105	23 - 83	75
	Cranked	66 - 105	33 - 70	65



193106

Contents

Part No.	Qty	Description	Part No.	Qty	Description
085421	1	Slide Hammer	095809	1	Extractor 6-8.5mm
085414	3	Straight Legs	095810	1	Extractor 8-11mm
085415	3	Cranked Legs	095811	1	Extractor 10.5-13mm
095820	1	Adaptor	095812	1	Extractor 13-18mm
085412	1	2 Way Beam (Twin)	095813	1	Extractor 18-22.5mm
085413	1	3 Way Beam (Triple)	095814	1	Extractor 22.5-30mm
085418	1	Adjustable Cone			

155105

Hydraulic Twin/Triple Leg Puller Kit

- Makes 8 different twin/triple leg pullers
- On metal storage/display panel complete with hooks
- Refer to pages 171-175 for component illustrations

Specifications

Part No.	Puller Spread Min - Max mm	Puller Reach Max mm	Ram Extension mm	Leg Style
155105	50 - 250	250	50 / 100 / 150	Standard

Contents

Part No.	Qty	Description
150000	1	Hydraulic Ram With Nose Piece
152412	1	Twin Head
153413	1	Triple Head
152422	1	Ram Extension - 50mm
152624	1	Ram Extension - 100mm
152726	1	Ram Extension - 150mm
152424	3	Leg - 100mm
152626	3	Leg - 150mm
152828	3	Leg - 200mm
152929	3	Leg - 250mm (Extra Wide)







155105

193105

Hydraulic Internal Extractor, Puller & Separator Kit with Slide Hammer

- For removing bearings, gears etc. where access behind components is too restricted to use standard pullers
- Drop forged, high quality steel, heat treated for strength and durability
- Extract components quickly and efficiently when conventional pullers cannot be used
- Slide hammer with 7 split collet internal extractors
- On metal storage/display panel complete with hooks

Specifications

				
Part No.	External Spread Min - Max mm	Internal Spread Min - Max mm	External Reach Max mm	Leg Style
193105	10 - 105	6 - 38	876	Thin Jaw



193105

Contents

Part No.	Qty	Description
150000	1	Hydraulic Ram With Nose Piece
193112	1	Twin Beam
086014	2	Leg 75mm - Thin Jaw
095000	1	Separator 10-55mm
095100	1	Separator 20-105mm
093115	2	Main Rod
093119	4	Extension Rod
093123	2	Extension Rod 5 inch
093500	1	Internal Race Extractor
085421	1	Slide Hammer
095809	1	Split Collet Extractor 6 - 8.5mm
095810	1	Split Collet Extractor 8 - 11mm
095811	1	Split Collet Extractor 10.5 - 13mm

Part No.	Qty	Description
095812	1	Split Collet Extractor 13 - 18mm
095813	1	Split Collet Extractor 18 - 22.5mm
095814	1	Split Collet Extractor 22.5 - 30mm
095815	1	Split Collet Extractor 30 - 38mm
095820	1	Adaptor
094000	1	Pulling Unit

155305









Comprehensive Hydraulic Puller/Separator/Extractor Kit

- Combines 155105 and 193105 above to make the most comprehensive set of pulling, separating and extracting options available
- Ideal workshop set for applications where a wide variety of pulling and extracting problems are likely to be encountered on daily basis
- Supplied on two wall mounted storage panels for ease of use and access
- Refer to the contents list previous page and above



155305

Specifications

							
Part No.	Puller Spread Min - Max mm	Puller Reach Max mm	Ram Extension mm	External Spread Min - Max mm	Internal Spread Min - Max mm	External Reach Max mm	Leg Style
155305	50 - 250	250	50 / 100 / 150	10 - 105	6 - 38	876	Standard/Thin Jaw

PULLERS

KIT CONTENTS

Mechanical Puller Kit Contents

		Mechanical Pullers & Puller Kits																																		
Description	Part No.	082700	082705	082800	082805	082900	083000	083100	083200	083300	083400	084200	084206	084900	084903	084905	084906	086000	086003	086010	086020	086030	086100	086200	086300	086400	086500	086504	086505	093003	093005	094003	660375			
Leg (reversible)	082714	3	3				2					3	3	3	3	3	3																			
	082814			3	3			2				3	3	3	3	3	3																			
Leg (std adjustable)	082914					3			2			3	3																							
	083314									2	3	3	3																							
Leg (thin jaw)	086014															2		2	3	3								2	2	2	2	2				
	086114																						2			3		3	3							
	086214																						2	2		3	3	3								
	086024																		3		2	3								2						
Twin Head	660362		1				1					1	1	1	1	1	1																	1		
	082812				1			1				1	1	1	1	1	1																			
	082912								1	1		1	1																							
	660362																																			
Triple Head	660363	1	1									1	1	1	1	1	1																	1		
	082813			1	1							1	1	1	1	1	1																			
	082913					1						1	1	1																						
Twin/Triple Head	660364																																	1		
Twin Beam	086012																	1	1		1							1	1							
	086112																					1		1				1	1							
	086212																						1					1	1							
Triple Beam	086013																		1	1		1														
	086513																									1	1	1	1							
Forcing Screw	082711	1	1				1					1	1	1	1	1	1	1	1	1	1	1	1	1				1	1							
	082811			1	1			1				1	1	1	1	1	1													1	1	1				
	082911					1			1	1	1	1	1										1	1		1	1	1								
	086111																						1			1		1	1							
	660361																																	1	1	
Separator	095000											1			1	1														1	1	1				
	095100											1				1																				
	095200											1																								
Main Rod	093015															2													1	2	2					
Twin Beam	093012															1													1	1	1					
Extension Piece	086016																		1		1	1														
Leg (double ended reversible)	660365																																		3	
Mini Bearing Puller	082300																													1						
Bolt & Nut M8 x 30	082718																																		2	
Metal Toolbox													•	•	•																					
Cardboard Carton		•	•	•	•	•	•	•	•	•	•				•			•	•	•	•	•	•	•	•	•	•	•			•	•	•			
Display Panel																•																				

Mechanical Puller Kit Contents

Description	Part No.	Mechanical External Separator Kits				Hydraulic Separator Kits Heavy Duty	
		093000	093100	093200	093300	193100	193200
Screw/thrust nut	082811	1					
	085123						
	093111		1				
	093211			1			
	093311				1		
Twin/Triple Step Plate	085112						
	085124						
Rod	085125						
	085126						
Main Rods, Nuts & Washers	093015	2					
	093115		2			2	
	093215			2			2
	093315				2		
Extension Rod	093119		4			4	
	093123		2			2	
	093219			4			4
	093319				4		
Twin Beam	093012	1					
	093112		1				
	093212			1			
	093312				1		
	193112					1	
	193212						1
Thrust Race	093121		1				
	093221			1			
	093321				1		
Separator	095000	1					
	095100		1			1	
	095200			1			1
	095300				1		
Washer	085130						
Hydraulic Ram (1 1/2"Ø) & nose-piece	150000					1	1
Ram Extension 100mm (4")	152624					1	
Ram Extension 150mm (6")	152726						1

Description	Size (mm)	Part No.	Slide Hammer Puller & Extractor Kits							
			085400	085403	085450	095800	095801	095802	095803	095804
Slide Hammer		085421	1	1	1	1	1	1	1	1
Adaptor		095820		1		1	1	1		1
Extractor	6 - 8.5	095809				1	1			
	8 - 11	095810				1	1			1
	10.5 - 13	095811		1		1	1			1
	13 - 18	095812		1		1		1		1
	18 - 22.5	095813		1		1		1		1
	22.5 - 30	095814		1		1		1		
	30 - 38	095815				1			1	
	38 - 50	095816				1			1	
50 - 60	095817				1			1		
2 Way Beam		085412	1	1						
		085454								
3 Way Beam		085413	1	1	1					
		085455			1					
Adjustable Cone		085418	1	1						
		085453			1					
Straight Leg		085414	1	1	1					
Cranked Leg		085415	1	1	1					
Forcing Screw		082103			1					
Extension		082104			1					
Pulling Unit		095805				1				
Nut		08545270			1					
Bolt		085421			1					

Hub Pullers Mechanical/Hydraulic

Description	Part No.	082203	082206	082503	082505	127303	127305	127306
Hydraulic Ram (1 1/2"Ø) & nosepiece	150000					1	1	1
Ram Extension 50mm (2")	152422					1	1	1
Leg 211mm	082214	3	6					
Leg 158mm	082514			3	5	3	5	5
Shock Handle	082519	1	1	1	1			1
Plunger Body	082212	1	1					
	127312			1	1	1	1	1
Force Screw 285mm	127311	1	1	1	1			1

KIT CONTENTS











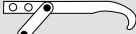

PULLERS

Kit Part No.	Description	152400	152600	152700	152800	152900	153400	153405	153600	153700	153800	153900	186100	186200	186300	186400	186500	127303	127305	127306	154003	154900	155004	155105	155305	155405	155000	155003	155008	155100	155200	155400	155700	155800	155900	156000	155208	186504	186505	193100	193101	193103	193104	193105	193200	193201									
095820	Adaptor																						1																																
193212	Twin Beam																																																						
095200	Separator 35-140mm (1 1/4"-5 1/2")																																																						
093215	Main Rod 332mm, 3/8" Dia.																																																						
093219	Extension Rod 272mm, 3/8" Dia.																																																						
093223	Extension Rod 152mm, 5" 5/8" Dia.																																																						
093500	Internal Race Extractor 40-150mm (1 1/2"-6")																							1																															
093111	Screw c/w Nut																																																						
093121	Thrust Race																																																						
093122	Beam Converter																																																						
093120	Thread Protector 63mm long																																																						
093220	Thread Protector 38mm long																																																						
127312	Plunger Body																	1	1	1																																			
082514	Hub Puller Leg																																																						
127311	Forcing Screw 1 1/2" Dia.																																																						
082519	Shock Handle (suits 127311)																																																						
086014	Thin Jaw Leg 75mm* (3")																																																						
095000	Separator 10-55mm 1/3" - 2 1/4" Dia.																																																						
086012	Twin Beam																																																						
082711	Forcing Screw (12mm Dia.)																																																						
085421	Slide Hammer																																																						
095809 to 095815	Split Collet Extractors (6-38mm)																																																						
	Metal Toolbox																																																						
	Cardboard Carton																																																						
	Display Panel																																																						
	Kit Part No.																																																						
	Description																																																						

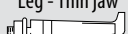









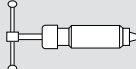







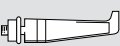

* Working dimensions. ** 1 only centre nut supplied with kits.

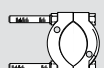
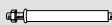
KIT CONTENTS

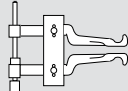
Mechanical Puller Component Dimensions (Actual)

Description	Part No.	Dimension
 Forcing Screw	082711	147mm M12 x 1.75
	086111	217mm M24 x 3.00
	082811	230mm M16 x 2.00
	082911	292mm M24 x 3.00
	086111	217mm M24 x 3.00
	093113	305mm 3/4 x 12 BSF
	093213	305mm 1" x 10 BSF
	093313	380mm 1 1/4 x 12UNF
 Twin Head	660362	75mm long M12
	082812	110mm long M12
	082912	165mm long M12
 Triple Head	660363	38mm Radius M12
	082813	55mm Radius M16
	082913	38mm Radius M24
 Leg Assembly - reversible	082714	124mm Long
	082814	236mm Long
 Leg Assembly - adjustable	082914	3.5mm Long
	083314	437mm Long
 Twin Beam	086012	118mm Long M12
	086112	210mm Long M24
	086212	285mm Long M24
 Triple Beam	086013	59mm Radius M12
	086513	125mm Radius M24
 Leg - Thin jaw	086014	122mm Long (75mm working dimensions)
	086024	162mm Long (110mm working dimensions)
	086114	215mm Long (150mm working dimensions)
	086214	290mm Long (225mm working dimensions)
 Twin Beam	093012	118mm Long M16
	093112	205mm Long
	093212	290mm Long M24
	093312	330mm Long
 Main Rod	093015	160mm Long (3/8" x 20 BSF)
	093115	254mm Long (1/2" x 16 BSF)
	093215	332mm Long (5/8" x 14 BSF)
	093315	375mm Long (1" x 14 UNS)
 Extension Rod	093123	127mm Long (1/2" x 16 BSF)
	093223	152mm Long (5/8" x 14 BSF)
	093119	285mm Long (1/2" x 16 BSF)
	093219	272mm Long (5/8" x 14 BSF)
	093319	304mm Long (1" x 14 UNS)
	093123	127mm Long (1/2" x 16 BSF)
 Extension Rod	093223	152mm Long (1/2" x 14 BSF)
	093120	63mm Long (1/2" x 16 BSF)
 Protector	093220	38mm Long (5/8" x 14 BSF)
	 Separator	095000
095100		20 - 105mm External Spread (1/2" x 16 BSF)
095200		35 - 140mm External Spread (5/8" x 14 BSF)
095300		50 - 175mm External Spread (1" x 14 UNS)

Hydraulic Puller Component Dimensions (Actual)

Description	Part No.	Dimension
 Hydraulic Ram with nose piece	150000	1 1/2" Dia. External
 Twin Head (with centre nut)	152412	1 1/2" Dia. Internal
 Triple Head (with centre nut)	153413	1 1/2" Dia. Internal
 Ram Extension	152422	50mm (2")
 Ram Extension	152624	100mm (4")
 Ram Extension	152726	150mm (6")
 Standard Leg	152424	165mm Long (100mm (4") Working Dimensions)
 Standard Leg	152626	215mm Long (150mm (6") Working Dimensions)
 Wide Standard Leg	152828	265mm Long (200mm (8") Working Dimensions)
 Standard Leg	152727	300mm Long (250mm (10") Working Dimensions)
 Wide Standard Leg	152929	300mm Long (250mm (10") Working Dimensions)
 Leg - Thin Jaw	086114	215mm Long (150mm (6") Working Dimensions)
	086214	290mm Long (225mm (9") Working Dimensions)
 Twin Beam	186212	290mm Long 1 1/2" Dia. Internal
	193112	210mm Long 1 1/2" Dia. Internal
	193212	290mm Long 1 1/2" Dia. Internal
 Triple Beam	186513	1 1/2" Dia. Internal
	 Separator	095000
095100		20-105mm (3/4" - 4 1/4")
095200		35-140mm (1 1/4" - 5 1/2")
 Main Rod	093115	254mm long (1/2" x 16 BSF)
	093215	332mm long (5/8" x 14 BSF)
	093315	375mm long (1" x 14 BSF)
 Extension Rod	093119	285mm long (1/2" x 16 BSF)
	093219	272mm long (5/8" x 14 BSF)
	093219	272mm long (5/8" x 14 BSF)
 Extension Rod 5 inch	093123	127mm long (1/2" x 16 BSF)
	093223	152mm long (5/8" x 14 BSF)
 Internal Race Extractor	093500	40 - 150mm
 Forcing Screw c/w Nut	093111	Forcing Screw c/w Nut
 Thrust Race	093121	-
 Beam Convertor	093122	-
 Protector	093120	63mm long (1/2" x 16 BSF)
	093220	38mm long (5/8" x 14 BSF)
 Twin Beam	086012	-

MECHANICAL PULLER COMPONENT ILLUSTRATIONS

Forcing Screws

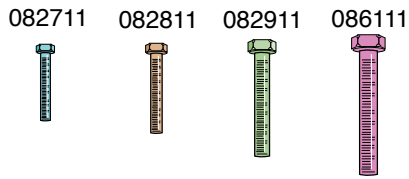

Twin Heads

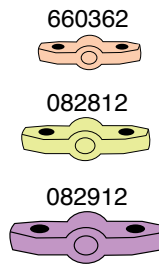

Twin Beams

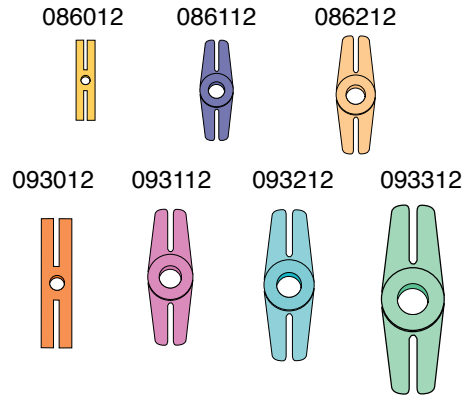

Screws Complete with Thrust Nut

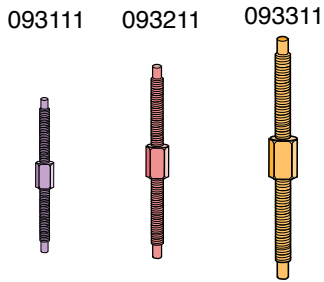

Triple Heads

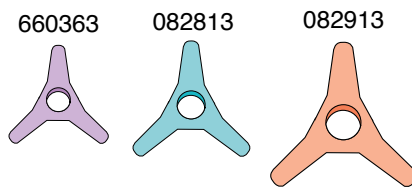

Triple Beams

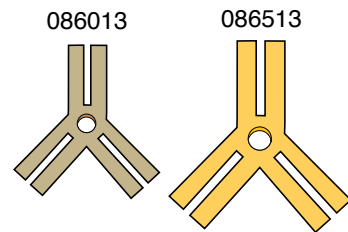

Standard Adjustable Leg Assemblies

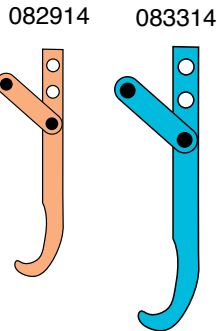

Thin Jaw Leg Assemblies (Working Dimensions)

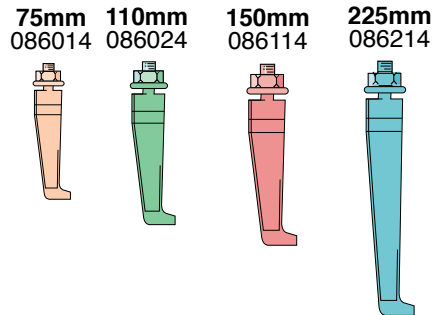

Protectors



Combination Twin/Triple Puller

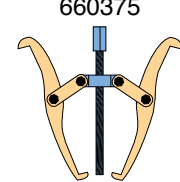

Mini Bearing Puller

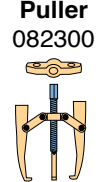

Rod Assemblies

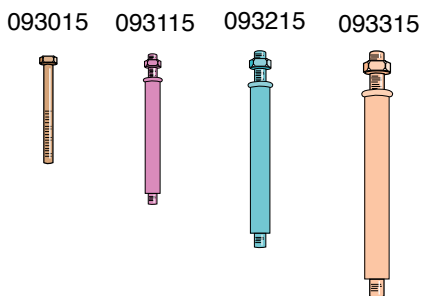

Double Ended Reversible Leg Assemblies

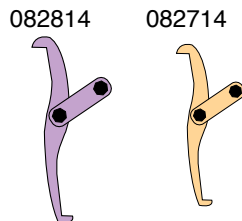

Internal Race Extractors

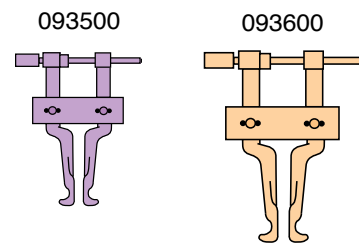

Separators

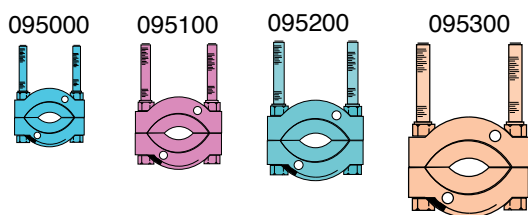

Thrust Races



Rod Extensions

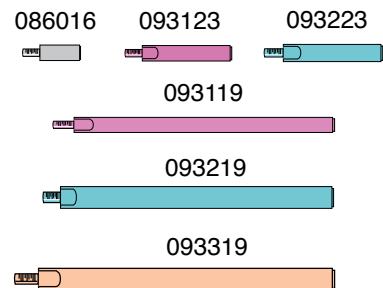

MECHANICAL PULLER ILLUSTRATIONS

TWIN LEG

Part No. 083000 (P.108)

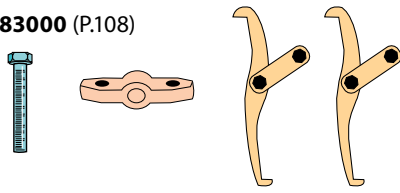

Part No. 083100 (P.108)

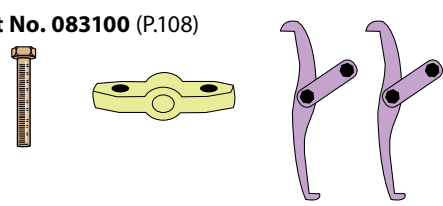

Part No. 083200 (P.108)

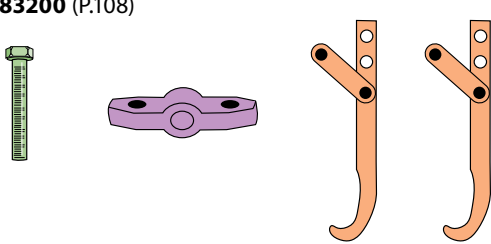

Part No. 083300 (P.108)

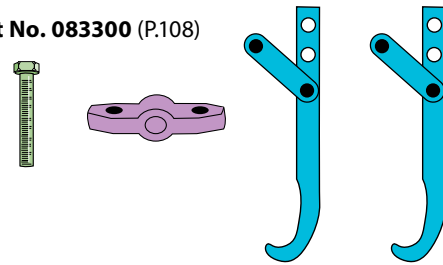

TRIPLE LEG

Part No. 082700 (P.109)

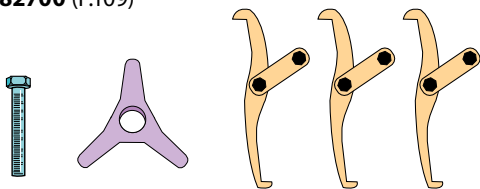

Part No. 082800 (P.109)

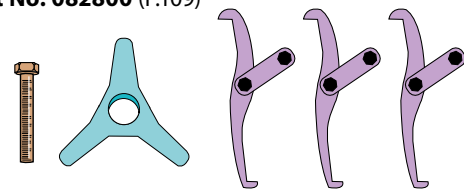

Part No. 082900 (P.109)

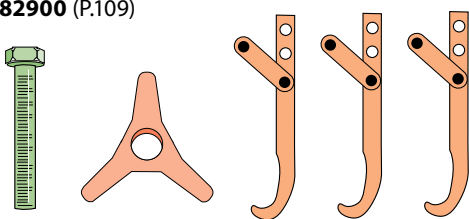

Part No. 083400 (P.109)

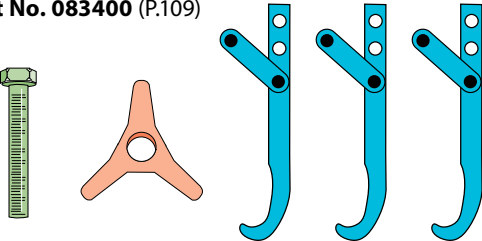

TWIN/TRIPLE LEG

Part No. 082705 (P.109)

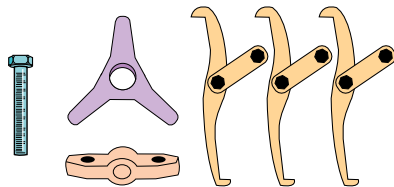

Part No. 082805 (P.109)

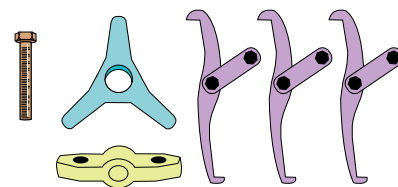

KITS - Twin/Triple Leg

Part No. 084900 (P.111)

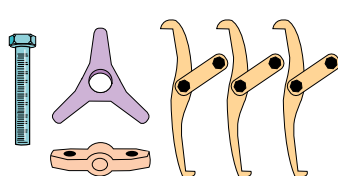

Part No. 084903 (P.111)

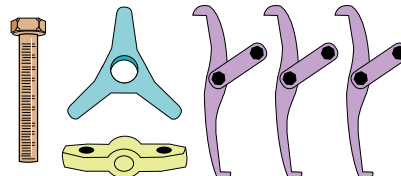

MECHANICAL PULLER ILLUSTRATIONS

KITS - Twin/Triple Leg cont.

Part No. 084200 (P.111)

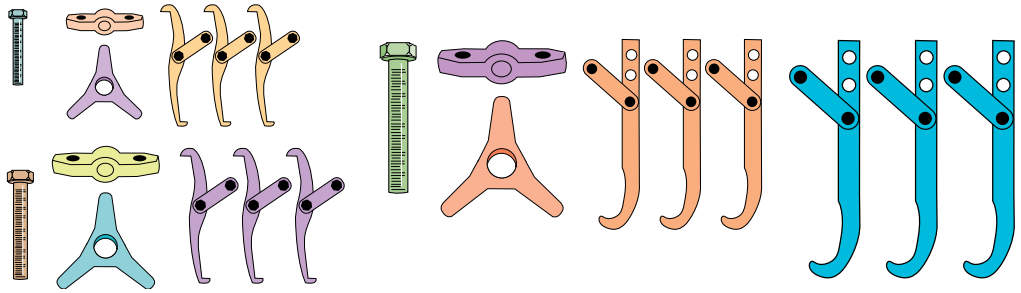

KITS - Twin/Triple Leg & Separator

Part No. 084906 (P.113)

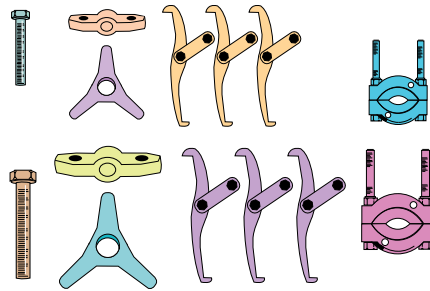

Part No. 084206 (P.114)

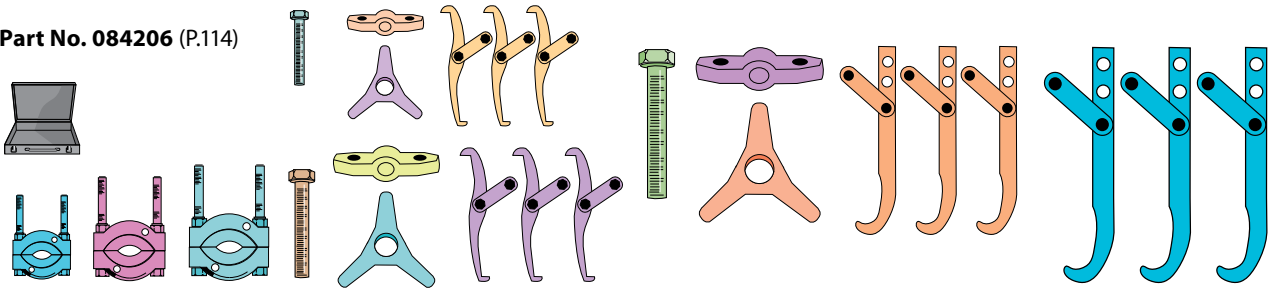

Part No. 094003 (P.114)

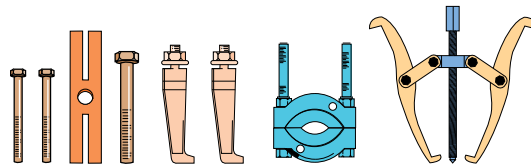

TWIN LEG - Thin Jaw

Part No. 086000 (P.115)

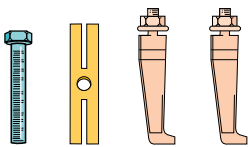

Part No. 086020 (P.115)

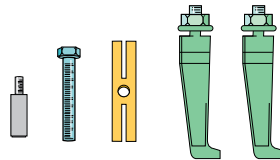

Part No. 086100 (P.115)

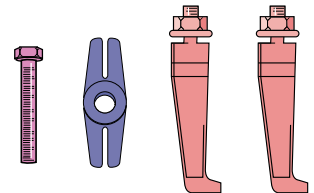

Part No. 086200 (P.115)

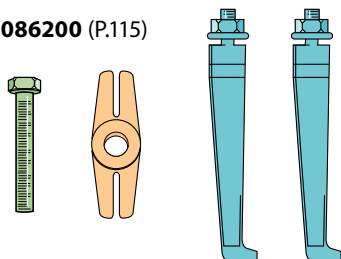

Part No. 086300 (P.115)

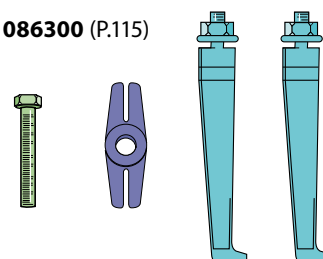

PULLERS

MECHANICAL PULLER ILLUSTRATIONS

TRIPLE LEG- Thin Jaw

Part No. 086010 (P.115)

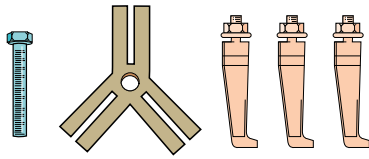

Part No. 086030 (P.115)

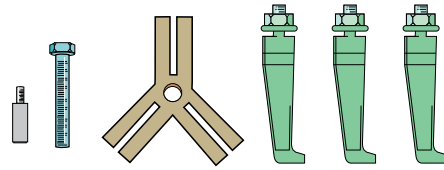

Part No. 086400 (P.115)

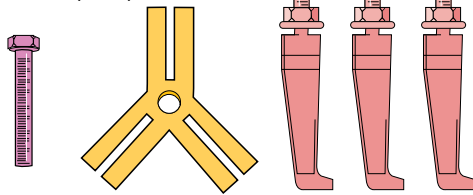

Part No. 086500 (P.115)

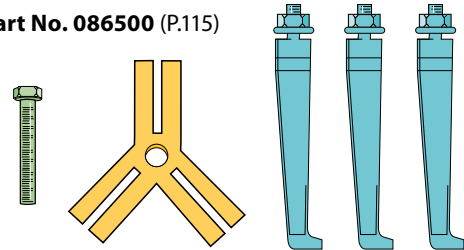

KITS - Thin Jaw Twin/Triple Leg

Part No. 086003 (P.116)

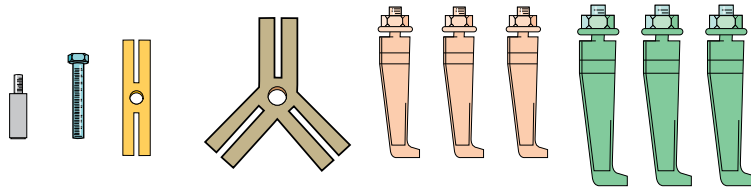

Part No. 086504 (P.116)

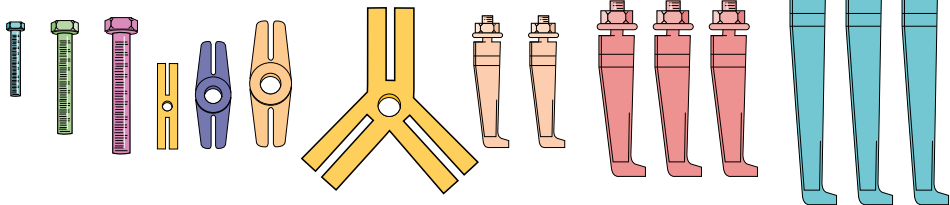

Part No. 086505 (P.116)



KITS - Thin Jaw Puller & Separator



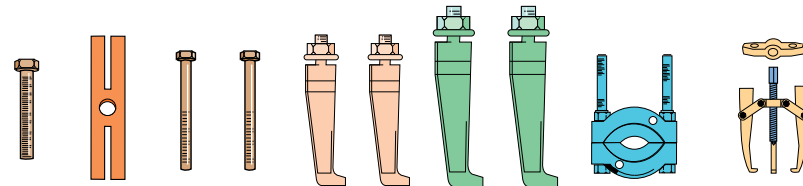



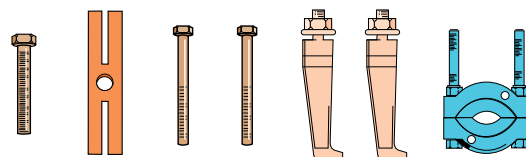





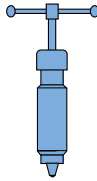



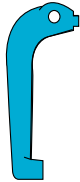
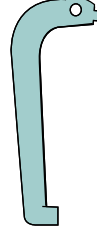
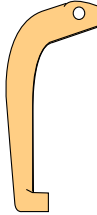
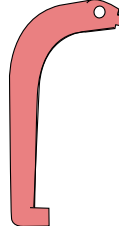
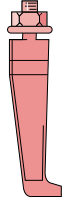
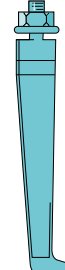



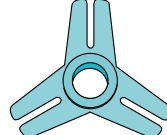
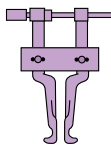

Part No. 093003 (P.117)

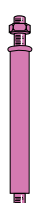
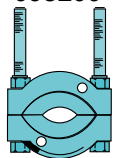
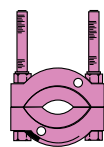

Part No. 093005 (P.117)



HYDRAULIC PULLER COMPONENT ILLUSTRATIONS

<p>Ram Extensions</p> <p>150mm 152726</p>  <p>100mm 152624</p>  <p>50mm 152422</p> 	<p>Hydraulic Ram complete with nose piece 150000</p> 	<p>Twin Head Assembly 152412</p> 	<p>Triple Head Assembly 153413</p> 	
<p>Standard Legs (Working Dimensions)</p>				
<p>100mm (4") 152424</p> 	<p>150mm (6") 152626</p> 	<p>250mm (10") 152727</p> 	<p>200mm (8") 152828</p> 	<p>250mm (10") 152929</p> 
<p>Thin Jaw Legs (Working Dimensions)</p> <p>150mm (6") 086114</p>  <p>225mm (9") 086214</p> 		<p>Twin Beams</p> <p>193212</p>  <p>186212</p>  <p>193112</p> 		<p>Triple Beam 186513</p> 
<p>Internal Race Extractor 093500</p> 	<p>Protectors</p> <p>093220</p>  <p>093120</p> 	<p>Rod Assemblies</p> <p>093215</p>  <p>093115</p> 	<p>Separators</p> <p>095200</p>  <p>095100</p>  <p>095000</p> 	
<p>Screw complete with thrust nut 093111</p> 	<p>Thrust Race 093121</p> 	<p>Rod Extensions</p> <p>093119</p>  <p>093123</p>  <p>093219</p>  <p>093223</p> 		
<p>Converter 093122</p> 				

PULLERS

15000 RAM

Part No. 150000 (P.118)

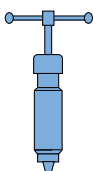

TWIN LEG

Part No. 152400 (P.119)

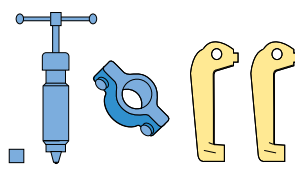

Part No. 152600 (P.119)

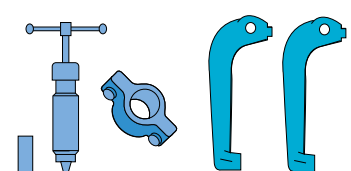

HYDRAULIC PULLER ILLUSTRATIONS

TWIN LEG cont.

Part No. 152700 (P.119)

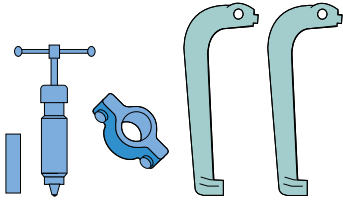

Part No. 152800 (P.119)

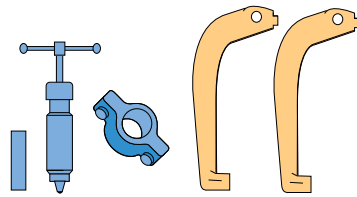

Part No. 12900 (P.119)

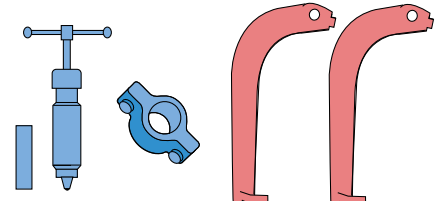

TRIPLE LEG

Part No. 153400 (P.119)

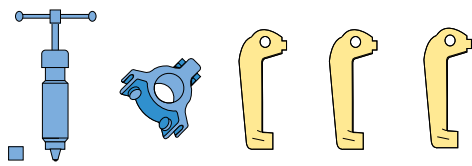

Part No. 153600 (P.119)

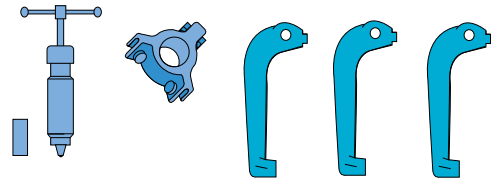

Part No. 153700 (P.119)

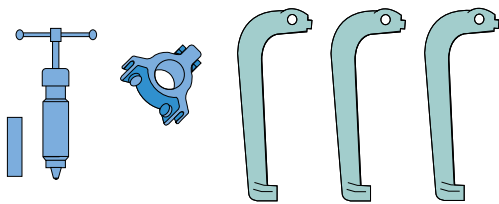

Part No. 153800 (P.119)

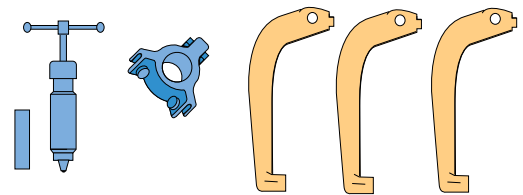

Part No. 153900 (P.119)

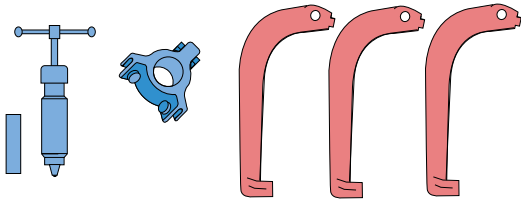

KITS - Twin/Triple Leg

Part No. 154900 (P.120)

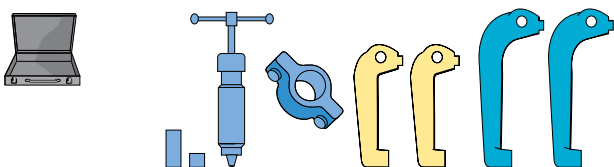

Part No. 153405 (P.120)

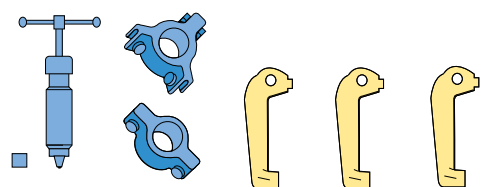

Part No. 155000 & 155003 (P.121)

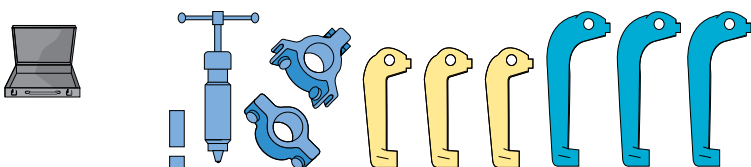

HYDRAULIC PULLER ILLUSTRATIONS

KITS - Twin/Triple Leg cont.

Part No. 155008 (P.121)

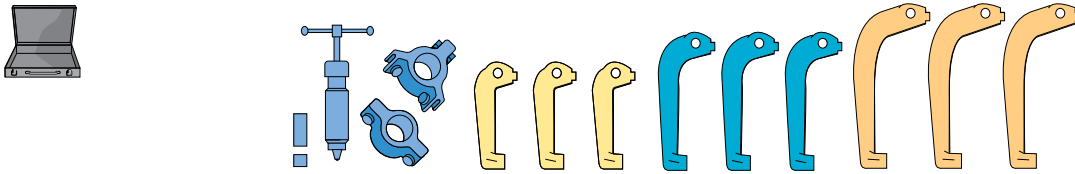

Part No. 155100 (P.122)

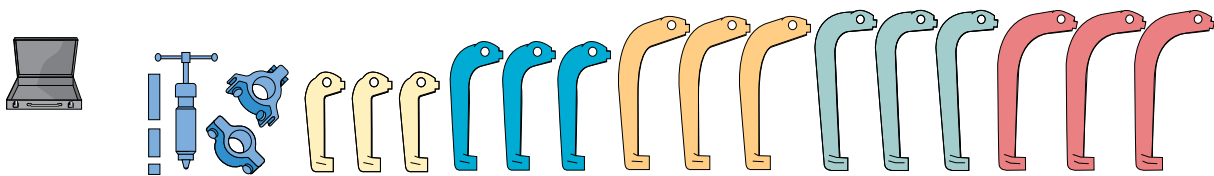

KITS - Combination Twin/Triple Leg

Part No. 154003 (P.123 & P132)

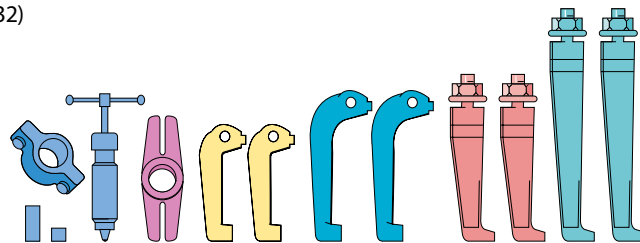

Part No. 154004 (P.123 & p133)

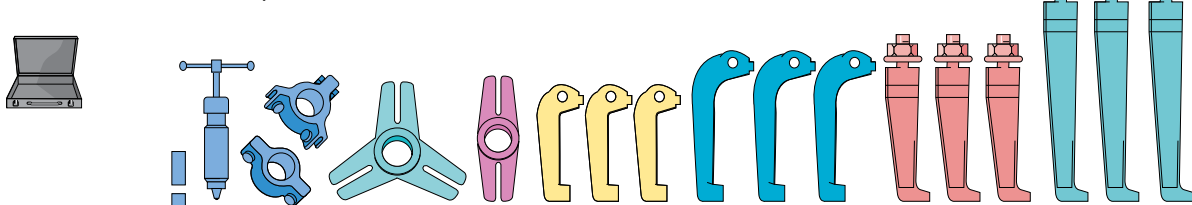

KITS - Twin/Triple Leg & Separator

Part No. 193100 (P.124)

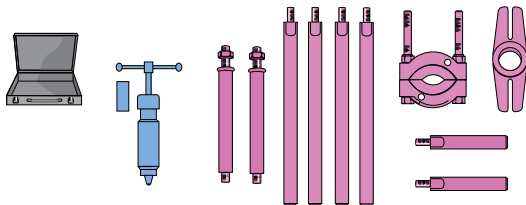

Part No. 193200 (P.124)

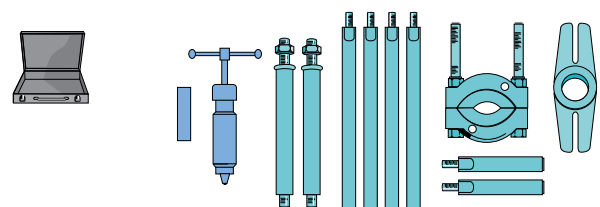

Part No. 156000 (P.125)

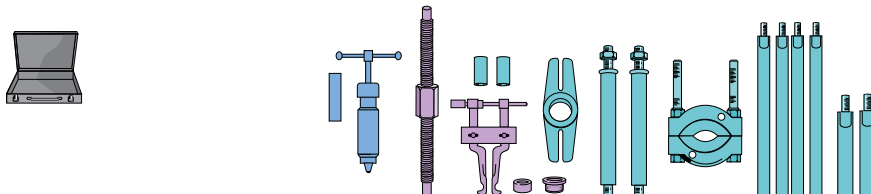

PULLERS

HYDRAULIC PULLER ILLUSTRATIONS

KITS - Twin/Triple Leg & Separator cont.

Part No. 155200 (P.125)

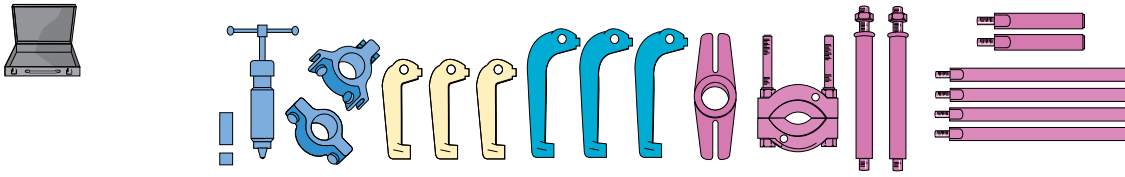

Part No. 155208 (P.126)

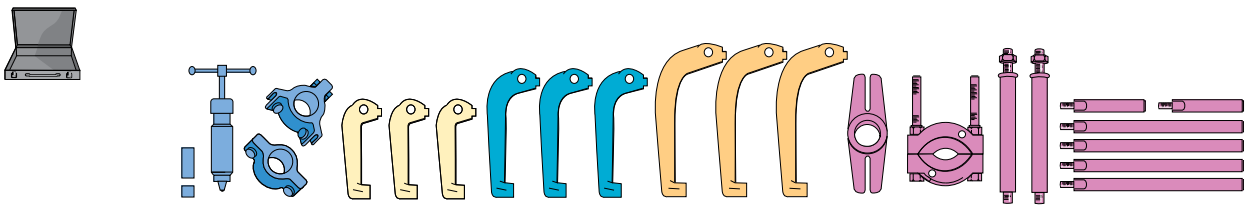

Part No. 155400 (P.127)

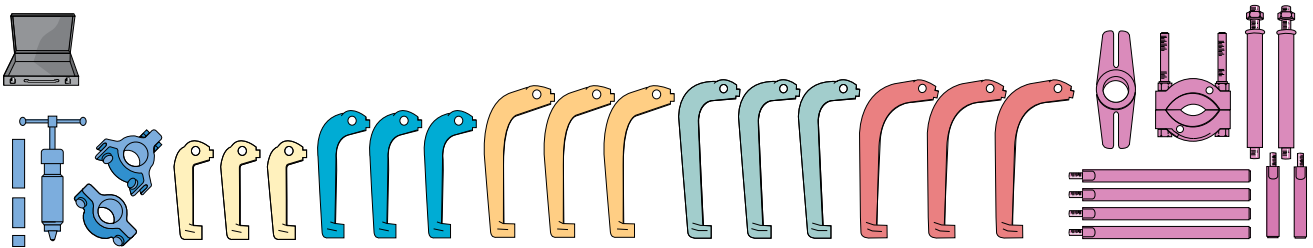

Part No. 155700 (P.128)

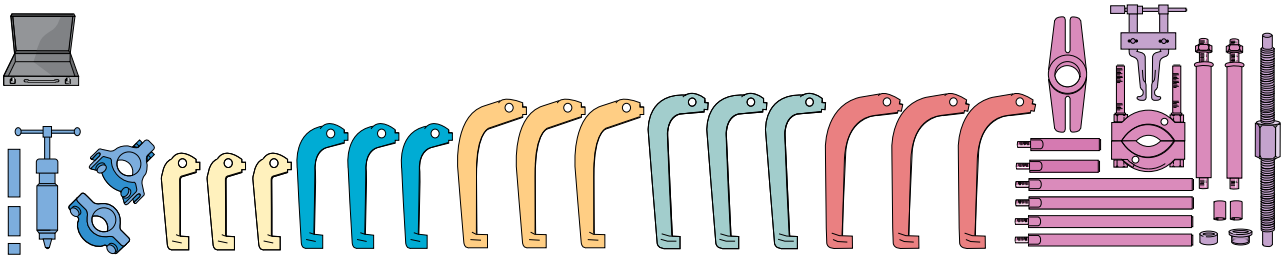

Part No. 155800 (P.129)

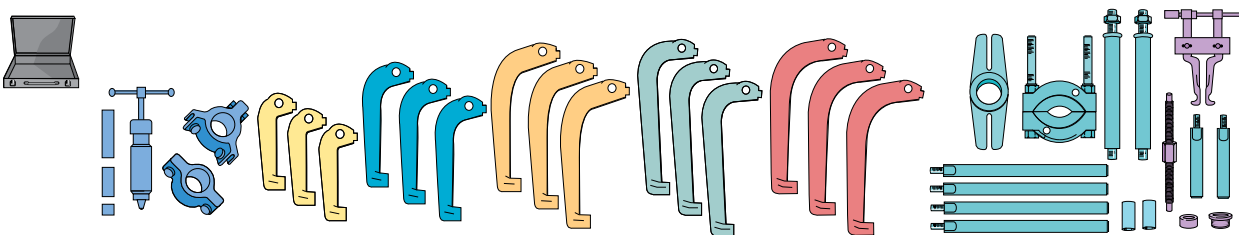

HYDRAULIC PULLER ILLUSTRATIONS

KITS - Twin/Triple Leg & Separator cont.

Part No. 155900 (P.130)

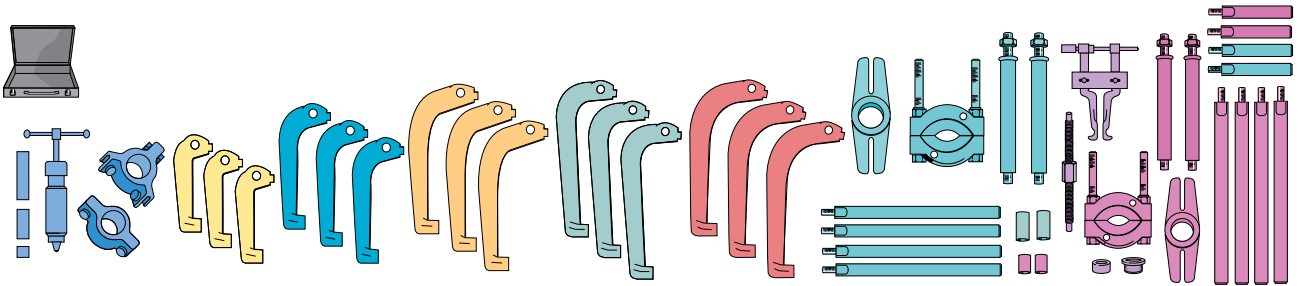

TWIN LEG - Thin Jaw

Part No. 186100 (P.131)

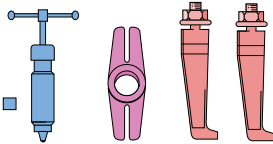

Part No. 186300 (P.131)

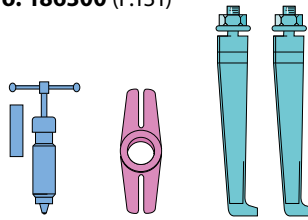

Part No. 186200 (P.131)

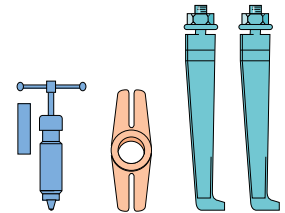

TRIPLE LEG- Thin Jaw

Part No. 186400 (P.131)

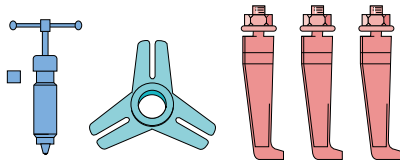

Part No. 186500 (P.131)

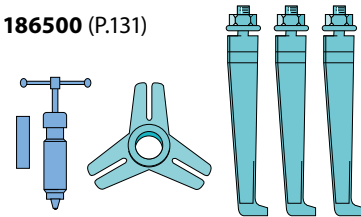

KITS - Thin Jaw Twin/Triple Leg

Part No. 186504 (P.132)

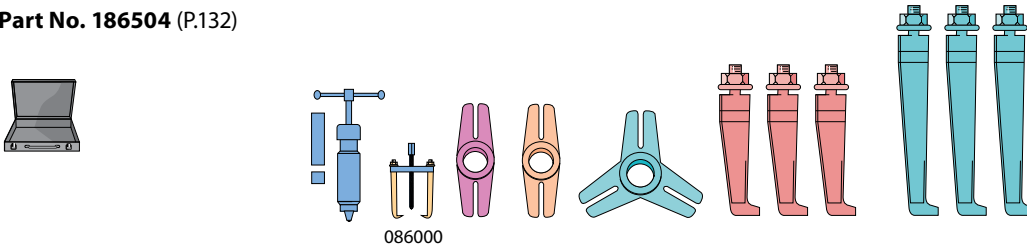

KITS - Thin Jaw Twin/Triple Leg & Separator

Part No. 193103 (P.133)

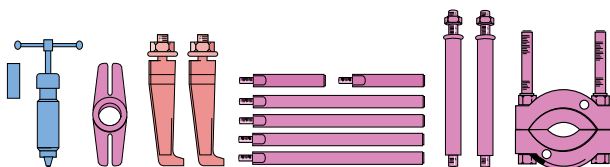

Part No. 193104 (P.133)

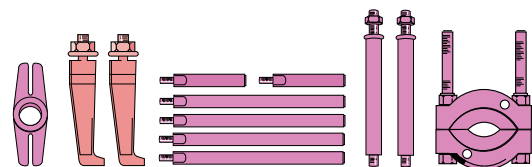

PULLERS

SLIDE HAMMER PULLER COMPONENTS & ILLUSTRATIONS

Extractors

095809 Ø 6-8.5mm	095810 Ø 8-11mm	095811 Ø 10.5-13mm	095812 Ø 13-18mm	095813 Ø 18-22.5mm	095814 Ø 22.5-30mm	095815 Ø 30-38mm	095816 Ø 38-50mm	095817 Ø 50-60mm
---------------------	--------------------	-----------------------	---------------------	-----------------------	-----------------------	---------------------	---------------------	---------------------

Slide Hammer Assembly
085421

Straight Legs
085414

Cranked Legs
085415

Pulling Unit
095805

Adjustable Cones

085418	085453
--------	--------

Bolt
085451

Nut
08545270

2 Way Beams

085412	085454
--------	--------

3 Way Beams

085413	085455
--------	--------

Adaptor
095820

Force Screw
082103

Extension
082104

COMBI PULL - Slide Hammer Pullers

Part No. 085400 (P.144)

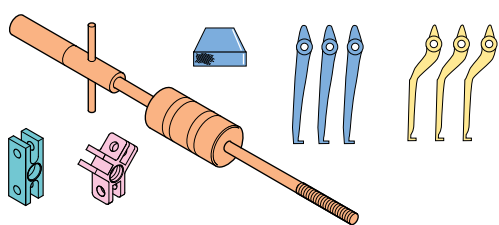

Part No. 085450 (P.145)

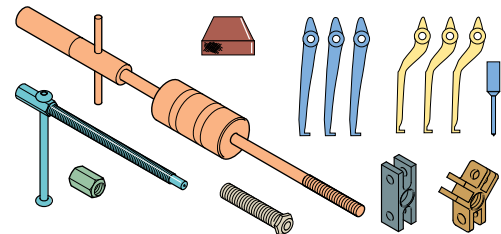

Part No. 085403 (P.145)

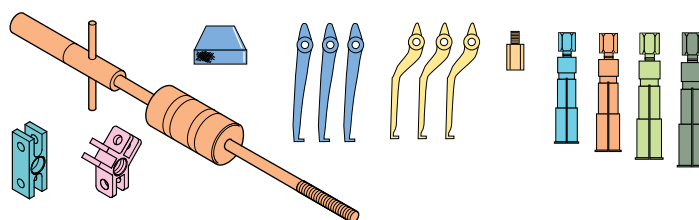

SLIDE HAMMER PULLER ILLUSTRATIONS

SPLIT COLLET EXTRACTOR PULLERS

Part No. 095801 (P.146)

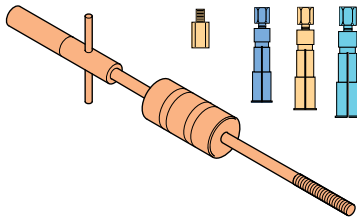

Part No. 095802 (P.146)

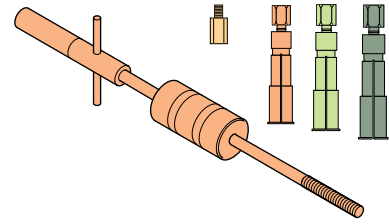

Part No. 095803 (P.146)

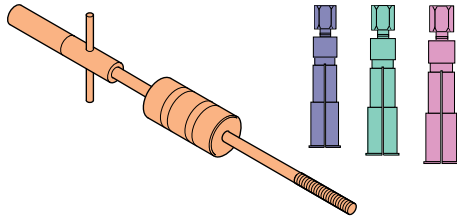

Part No. 095804 (P.146)

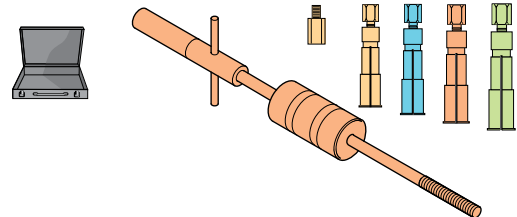

Part No. 095800 (P.147)

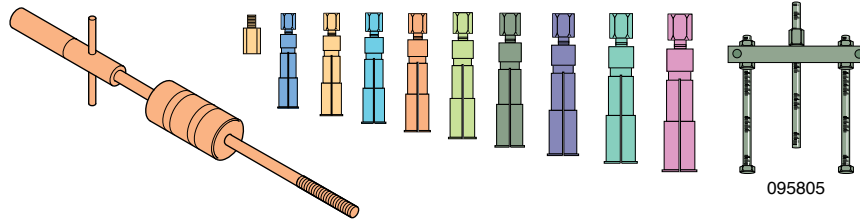

EXTERNAL BEARING PULLERS

Part No. 093000 (P.148)

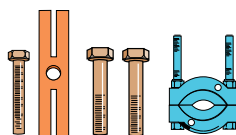

Part No. 093100 (P.148)

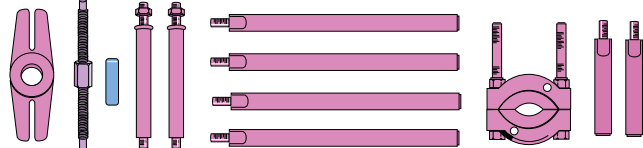

Part No. 093200 (P.148)

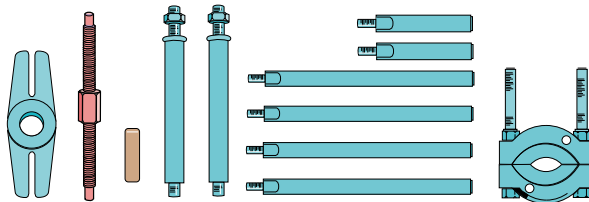

Part No. 093300 (P.148)

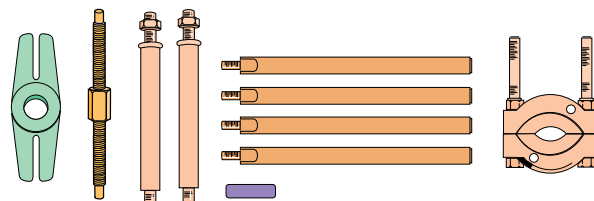

Part No. 094500 (P.148)

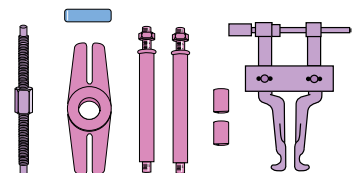

PULLERS

MULTIPULL® COMPONENTS & ILLUSTRATIONS

Forcing Screws 098011 0982811 093113 			Beams 098012 098112 098212 			Rod Assemblies 098015 098115 098215 		
Rod Extensions 098217 195mm for 098200 098218 295mm 098017 95mm for 098000 098120 195mm for 098100 098119 95mm for 098100 098019 			Spindle End Pieces 098239 098039 098139 			Thrust Washer 098213 		Thrust Nut 098214
Adaptors								
	098021	098022	098023	098124	098125	098126		
	1 5.5mm	2 6mm	3 8mm	4 9mm	5 11mm	6 12.5mm		
	098227	098228	098229	098230	098231	098232		
	7 16mm	8 19mm	9 22mm	10 25mm	11 28mm	12 31.75mm		

Part No. 098000 (P.150)

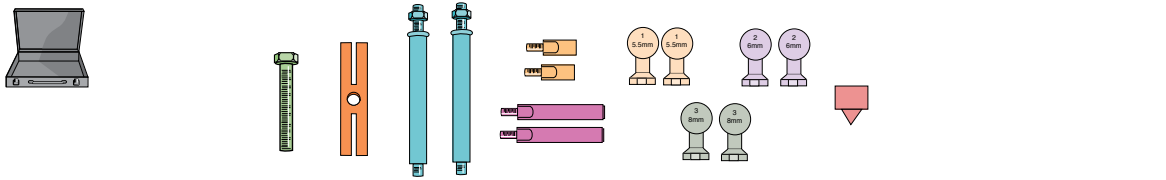

Part No. 098100 (P.150)

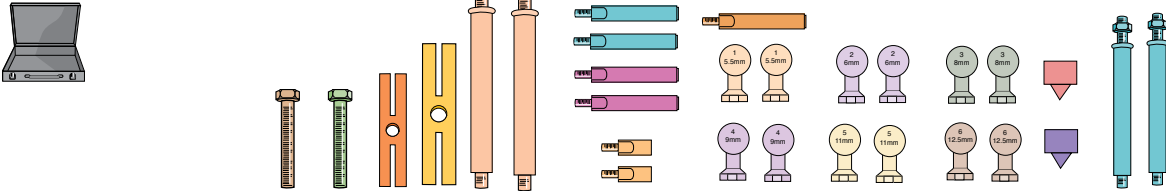

Part No. 098200 (P.150)

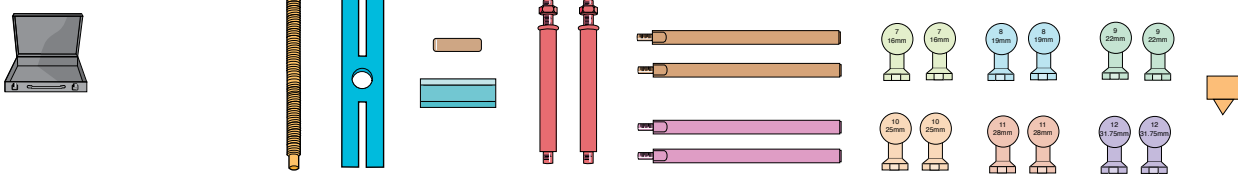



HYDRAULICS

 Sykes-Pickavant®

HYDRAULICS

Sykes-Pickavant Loadstar Plus heavy duty pullers are renowned for their durability, immense pulling power and versatile range of kit options. Sykes-Pickavant hydraulic equipment builds upon the legendary Loadstar heritage and offers a first-class range of hydraulic pumps, cylinders and jacking kit options.

Rugged yet lightweight construction using only the highest quality components provides the perfect combination of strength and portability, ideal for incremental movement of heavy loads across multiple industries and applications.

PUMP DESIGN

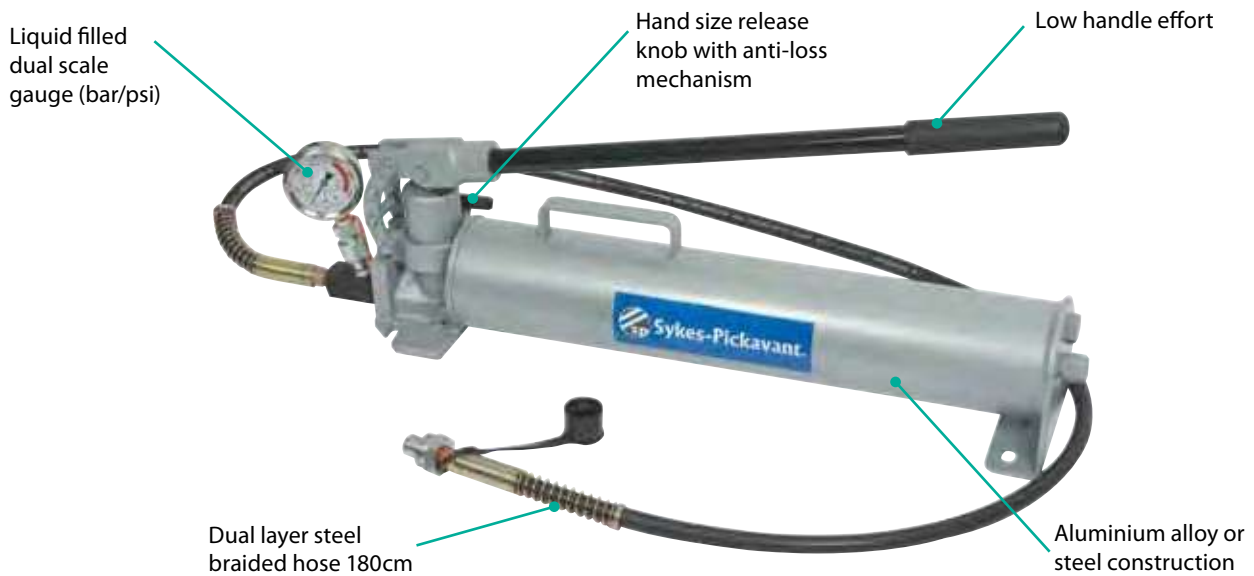

CYLINDER DESIGN





PUMPS

Fill oil reservoir only to recommended level ensuring cylinder is fully retracted

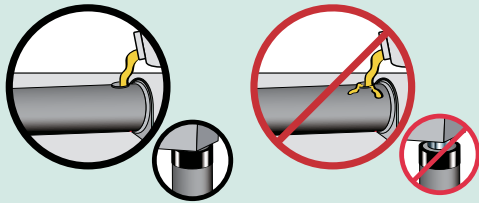

Do not use handle extenders or cheater bars. Hand pumps should operate with minimal effort when used correctly

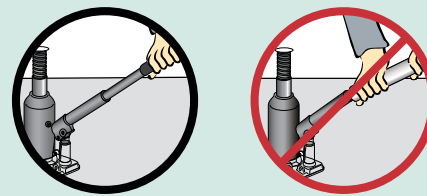

CYLINDERS AND JACKS

Select a cylinder with a least 20% more capacity than the load weight. Be aware of possible load shift



Do not use damaged or worn components. Inspect each component prior to use

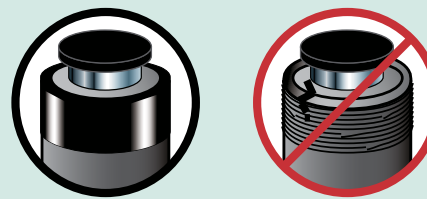

The load must be centred on the ram or equally distributed on multiple rams. Off centre loading can cause load slippage and damage the cylinder

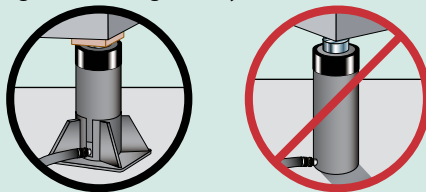

For multiple cylinder lifts the 'load balance' must be considered to correctly determine the location and number of lifting points to distribute the load evenly

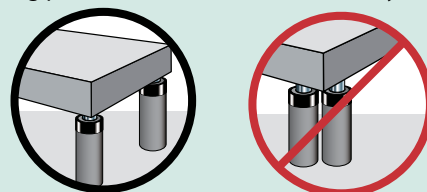

Do not use hydraulic cylinders as permanent supports. If prolonged support is required use correctly weight rated cribwork

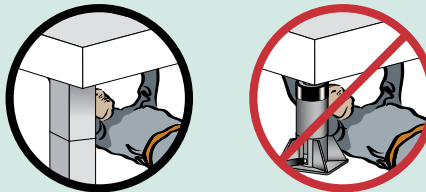

Avoid extreme heat or weld splatter near hydraulic components as this may cause damage. Hydraulic fluid can ignite if exposed to extreme temperatures



HOSES AND CONNECTIONS

Do not drag or carry hydraulic pumps or cylinders by the connected hose. This may cause damage to components



Keep hose and fittings away from high traffic areas. Contact with heavy or sharp objects may damage the hose internally

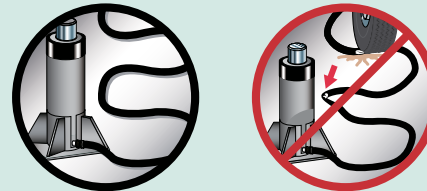

Ensure quick coupler fittings are fully engaged to prevent blow off and leakage under pressure. Fittings should secure with minimal effort

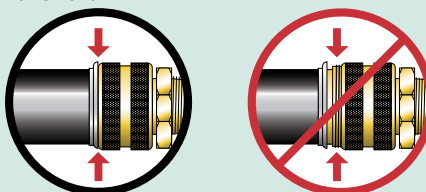

Never attempt to disconnect hydraulic hoses, fittings or couplers under pressure. The cylinder and hoses should be fully unloaded and depressurised prior to disconnecting

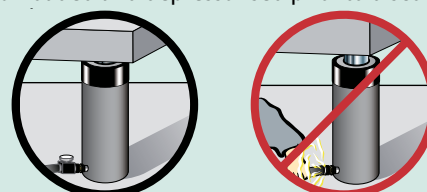

HYDRAULIC PUMPS



Pumps

- Sykes-Pickavant hydraulic pumps are available as lightweight aluminium alloy or rugged steel construction. Both types provide the durability and long service life which Sykes-Pickavant customers have come to expect, while also maximising portability and manoeuvrability for on-site applications
- Each pump is supplied with a 2.5" diameter gauge, liquid filled to protect for shock and needle vibration, a heavy duty hose featuring dual layer steel braided reinforcement with spring guard at each end to protect adaptors and a self sealing ball type coupling system

Part No.	Pressure Rating (Bar)		Oil Capacity (C.C.)	Oil Volume Per Stroke (C.C.)		Weight (kg)	Length (mm)	Width (mm)	Depth (mm)
	1st Stage	2nd Stage		1st Stage	2nd Stage				
200160	28	700	2000	40	3	12	725	150	225
200170	13.8	700	1000	12.9	2.3	3.5	542	110	135
200175	700 Max.		750	9 CFM Air Consumption		5.4	442	170	179

200160

High Capacity, Two Speed Steel Pump

- Rugged steel body construction for long life and confidence in extreme operating conditions
- High volume fluid capacity with rapid first stage for speed and efficiency
- Ideal for workshop, construction, mining or rescue use
- Features hand sized release knob with anti loss mechanism ideal for industrial requirements
- Internal overload valve prevents pump from being used beyond its rated capacity



200170

Two Speed Aluminium Pump

- Portable two stage hydraulic pump with low handle effort for ease of use
- Lightweight aluminium alloy construction allows effortless manoeuvrability and portability at onsite applications
- Features hand sized release knob with anti loss mechanism ideal for industrial requirements



200175

Air-Powered, Aluminium Hydraulic Pump

- Compressed air powered hydraulic pump designed for use with single acting cylinders
- Lightweight aluminium alloy construction built for long life and portability
- Automatic overload relief valve protects hydraulic components and ensures safe working environment for the operator
- Unique inlet and outlet design features a low noise exhaust system



HYDRAULIC CYLINDERS



Cylinders

- All Sykes-Pickavant hydraulic cylinders meet worldwide safety standards and are built tough to endure real world industrial and construction site conditions. Heavy duty steel plated springs provide fast and complete return every time to ensure trouble free operation and long service life
- All cylinders feature piston blow out protection which limits piston travel at the end of the stroke to add strength and safety allowing the cylinder to be operated at full stroke

Part No.	Max Working Pressure (Bar)	Stroke (mm)	Oil Capacity (C.C.)	Dia (mm)	Operating Range (mm)	
					Retracted	Extended
200120	700	158.5	610	88	273	431.5
200130	700	65	310	117	178.5	243.5
200150	700	50	368	160	212	262

200120

20 Tonne Hydraulic Cylinder

- Steel cylinder, single acting plunger with spring return
- Pistons hard chromed
- Ram inside roll polished
- Heavy duty spring for fast and full return
- Stop rings for piston blow-out protection
- Rod wiper protects inner cylinder from dirt contamination



200130

30 Tonne Hydraulic Cylinder

- Aluminium cylinder, single acting hollow plunger with spring return
- Large bearing surfaces for side load protection
- Heavy duty spring for fast and full return
- Hard anodize coating reduces wear and corrosion
- Stop rings for piston blow-out protection
- Rod wiper protects inner cylinder from dirt contamination
- Lightweight aluminium construction
- Supplied with three steel inserts (solid, hollow plain and hollow threaded)



200150

50 Tonne Hydraulic Cylinder

- Aluminium cylinder, single acting hollow plunger with spring return
- Large bearing surfaces for side load protection
- Heavy duty spring for fast and full return
- Lightweight aluminium construction
- Stop rings for piston blow-out protection
- Rod wiper protects inner cylinder from dirt contamination
- Supplied with three steel inserts (solid, hollow plain and hollow threaded)
- Hard anodize coating reduces wear and corrosion
- Convenient carry handle



JACK AND PRESS KITS

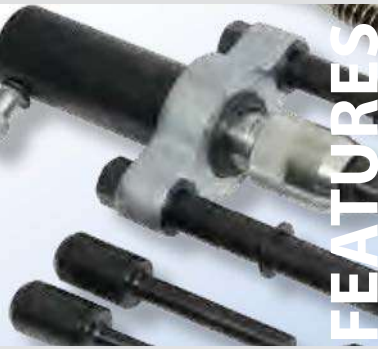

FEATURES

Jack and Press Kits

- Hydraulic jack and press frame arrangements are configured using the light weight 200170 Two Speed Aluminium Hydraulic Pump ensuring maximum portability
- Available in 20, 30 and 50 tonne kits to accommodate a broad spectrum of uses and applications such as mining, construction, steel erecting and rescue
- Cylinders must be placed in a position to provide a straight direct lift to avoid extreme side loading which can damage the internal sleeve

200133

20 Tonne Hydraulic Jack Kit

- 20 tonne jacking system for incremental movement of heavy loads
- Top and bottom plate configuration allows the load to be spread over a larger area
- Supplied in metal case

Contents

Part No.	Qty	Description
200170	1	Two Speed Aluminium Hydraulic Pump
200120	1	20T Hydraulic Cylinder
200143	1	Autogrip Collar Adaptor
200121	1	20T Cylinder Push Plate
200124	1	20T Cylinder Base Plate



200134

20 Tonne Hydraulic Toe Lift Kit

- 20 tonne toe lift jacking system for incremental movement of heavy loads
- Base plate and toe lift enables lift from a lower height in confined spaces
- Supplied in metal case

Contents

Part No.	Qty	Description
200170	1	Two Speed Aluminium Hydraulic Pump
200120	1	20T Hydraulic Cylinder
200143	1	Autogrip Collar Adaptor
200123	1	Toe Lift
200124	1	20T Cylinder Base Plate



JACK AND PRESS KITS

212000

20 Tonne Hydraulic Press Frame Kit

- Standalone portable press frame system for pin pushing applications
- Includes five extractor (pushing) pins ideal for difficult access areas such as HGV king pins
- Autogrip collar adaptor for quick change of pins
- Moveable top block of frame allows adjustment of throat depth for variable applications
- Includes hydraulic pump and 20 tonne cylinder
- Supplied in metal case

Contents

Part No.	Qty	Description
200170	1	Hydraulic Pump
200120	1	20T Hydraulic Cylinder
200144	1	Extractor Pin 25 x 150
200145	1	Extractor Pin 50 x 150
200146	1	Extractor Pin 38 x 150
200147	1	Extractor Pin 18 x 75
200148	1	Extractor Pin 20 x 150
200149	1	Autogrip Collar Adaptor
200395	1	Press Frame



200141

30 Tonne Hydraulic Jack Kit

- 30 tonne jacking system for incremental movement of heavy loads
- Aluminium cylinder, single acting hollow plunger with spring return
- Supplied in metal case

Contents

Part No.	Qty	Description
200170	1	Two Speed Aluminium Hydraulic Pump
200130	1	30T Hydraulic Cylinder



200153

50 Tonne Hydraulic Jack Kit

- 50 tonne jacking system for incremental movement of heavy loads
- Aluminium cylinder, single acting hollow plunger with spring return
- Supplied in metal case

Contents

Part No.	Qty	Description
200170	1	Two Speed Aluminium Hydraulic Pump
200150	1	50T Hydraulic Cylinder



ACCESSORIES

217200

Pump Hose

- Heavy duty hose featuring dual layer steel braided reinforcement
- Includes spring guard at each end to protect adaptors
- Maximum working pressure: 700 bar
- Length: 180cm (6 feet)
- End fitting: 3/8" NPT



217400

Hydraulic Coupling

- Self sealing ball type coupling system
- Supplied complete with both male and female halves (ram/hose)
- End fitting: 3/8" NPT

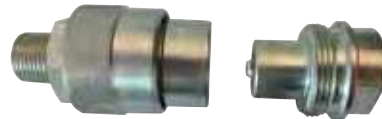

217900

Gauge and Block Assembly

- 2.5" diameter gauge, liquid filled to protect for shock and needle vibration
- Dual scale 0 – 1,000 bar (0 – 15,000psi)
- Gauge thread: 1/4" NPT
- Block thread: 3/8" NPT



NUMERICAL INDEX

Part No.	Page No.	Part No.	Page No.	Part No.	Page No.	Part No.	Page No.
012000	94	031600	94	042300	79	057101	76
013703	23	032000	29	042400	79	057111	76
013900	36	032002	29	042500	79	057112	76
014900	86	032005	87	043000	77	057115	76
015500	21	032010	29	043100	79	057121	76
015600	93	032200	17	045400	84	057122	76
015601	93	032800	66	045403	84	057125	76
015602	93	033600	94	045404	84	057300	73
015603	93	033604	94	045405	84	057400	73
016400	20	034800	47	045406	84	057800	73
016900	40	034811	47	045500	83	058001	74-75
017500	38	034900	48	045800	83	058103	74
017800	20	034991	48	046000	83	058201	74
018000	93	034995	48	050500	58, 152	058301	74-75
018200	93	036108	50	051201	73	058401	74-75
021600	45	036130	49	051600	84	059200	84
021650	45	036150	49	052700	76	059400	73
022100	45	036155	49	052800	71	059500	73
023400	46	036192	49	052900	70	059700	73
024600	46	036194	50	053000	71	059800	73
025600	46	036198	50	053100	71	065008	80
027000	43	036900	83	053200	71	065011	80
027001	43	038000	19	053700	71	065012	80
027002	43	038300	21	054301	72	065014	80
027008	43	038400	21	054601	72	065020	81
027009	43	038600	21	054801	72	065025	81
027250	42	038900	21	054901	72	065030	81
027266	42	039500	19	055001	72	065035	81
027295	42	039650	18	055201	72	065050	80
027297	42	039700	18	055401	72	066000	82, 96
027300	45	039800	18	055501	72	066001	82, 96
027400	46	039900	17	055601	72	066003	82, 96
027600	36, 95	040011	77	055701	72	066008	82, 96
028000	16	040101	51, 84, 96	055801	72	066009	82, 96
028001	16	040201	77	056000	70	066012	82, 96
028002	16	040213	77	056100	70	076100	50
028003	16	040265	77	056200	70	076101	50, 95
028100	16	040280	77	056500	70	076500	66
028101	16	040900	77	056600	71	077120	50
028102	16	042000	78	056800	70	077400	22, 96
028103	16	042100	78	056900	71	077444	22, 96
028300	23, 95	042200	78	057100	76	077524	22

NUMERICAL INDEX

Part No.	Page No.	Part No.	Page No.	Part No.	Page No.	Part No.	Page No.
080500	57	084876	55	095000	149	155105	160
080600	58	084900	111	095100	149	155106	158
080700	58	084903	111	095200	149	155107	158
080750	58	084905	157	095300	149	155108	159
081000	63	084906	113	095800	147	155200	125
082150	110	084907	156	095801	146	155208	126
082203	62, 151	085300	59, 152	095802	146	155305	161
082206	62, 151	085306	59, 152	095803	146	155400	127
082300	110	085309	63, 153	095804	146	155405	159
082450	110	085316	59, 152	095805	147	155700	128
082503	62, 151	085400	144	096050	112	155800	129
082505	62, 151	085403	145	096100	112	155900	130
082519	118	085450	145	096350	112	156000	125
082545	61	085503	23	096450	112	180700	58
082700	109	085700	38	098000	150	185000	60
082705	109	085810	38	098100	150	185500	60
082800	109	085815	38	098200	150	185800	37
082805	109	086000	115	127300	118	185825	37
082900	109	086003	116	127303	62, 151	185830	37
083000	108	086010	115	127305	62, 151	186100	131
083100	108	086020	115	127306	62, 151	186200	131
083200	108	086030	115	127311	118	186300	131
083300	108	086100	115	150000	118	186400	131
083400	109	086200	115	150024	118	186500	131
083800	52	086300	115	152400	119	186504	132
083805	52	086400	115	152600	119	186505	157
083900	52	086500	115, 155	152700	119	193100	124
083901	53	086504	116	152800	119	193103	133
083902	52	086505	156	152900	119	193104	133
083903	52	093000	148	153400	119	193105	161
083904	53	093003	117	153405	120	193106	160
083905	53	093005	117	153600	119	193200	124
083911	53	093100	148	153700	119	200120	183
083912	53	093120	149	153800	119	200130	183
083913	53	093200	148	153900	119	200133	184
083915	53	093220	149	154003	123, 132	200134	184
084200	111	093300	148	154004	123, 133	200141	185
084206	114	093320	149	154900	120	200150	183
084500	54	093500	149	155000	121	200153	185
084800	56	093600	149	155003	121	200160	182
084850	56, 63	094003	114	155008	121	200170	136, 182
084875	55	094500	148	155100	122	200175	182

NUMERICAL INDEX

Part No.	Page No.	Part No.	Page No.	Part No.	Page No.	Part No.	Page No.
201008	134	314000	5	331515	25	660905	20
201012	134-135	314003	5	331516	25	660925	45
201020	134-135	314005	5	331517	25	660935	93
202000	136-137	314009	5	331522	25	660950	96
202001	136-137	314011	5	331535	25	660990	93
202020	136-137	314020	5	331541	25	661950	94
202030	136-137	314050	6	331548	25	670006	18, 96
202040	136, 138	314200	8	331555	25	800020	98
202045	136, 138	314219	10	331556	25	800060	98
202050	136, 139	314275	7	331558	25	800100	98
203000	136, 140	314280	11	331561	24	800101	98
203001	136, 140	314285	11	331563	25	800116	98
203020	136, 140	314288	10	331565	25	800200	98
203050	136, 141	314289	10	331567	25	800300	98
205000	136, 142	314291	10	331568	25	800306	98
205001	136, 142	314292	10	331571	25	800330	98
205020	136, 142	314293	10	331572	25	800336	98
205050	136, 143	314294	10	331573	25	800399	98
208700	64-65	314295	9	331575	25	800400	100
208730	64-65	314300	12	331578	24	800408	100
208750	64-65, 153-154	314400	40	331595	24	800432	103
208760	153-154	314500	39	331900	26	800433	103
208795	64-65, 153-154	314595	39	331905	26	800500	100
212000	136, 138, 185	314600	34	331950	29	800550	100
212001	136, 138	314610	34	335300	47	800582	100
217200	186	314620	34	660210	19	800600	102
217400	186	314650	35	660310	57	800655	102
217900	186	314660	35	660370	17	800660	102
300400	90	314680	31	660373	17	800665	102
300410	90	314700	15	660375	109	800700	101
300420	87	314702	15	660430	19	800750	101
300424	86	314850	32	660490	58	800801	104
300425	87	314860	30	660500	47	800802	104
300426	86	314865	32	660501	47	800805	99
300430	91	314875	31	660550	57	800806	99
300440	91	314895	32	660650	51, 95	800820	66, 104
300475	65, 92	314920	33	660740	66	800935	101
300500	88	314925	33	660745	66		
300535	89	316600	22	660887	95		
300725	35	323700	92	660902	20		
313800	13	331400	28	660903	20		
313805	13	331512	25	660904	20		

ALPHABETICAL INDEX

Description	Page No.
#	
20 Tonne Hydraulic Jack Kit	184
20 Tonne Hydraulic Steel Cylinder	183
20 Tonne Hydraulic Toe Lift Kit	184
270 Series Pipe Flaring Tools	43
30 Tonne Hydraulic Aluminium Cylinder	183
30 Tonne Hydraulic Jack Kit	185
50 Tonne Hydraulic Aluminium Cylinder	183
50 Tonne Hydraulic Jack Kit	185
A	
Adaptor - Brake Caliper Windback Tool	50
Adaptor - Drive Adaptor Caliper Windback Tool	50
Adaptor - Pressure Brake Bleeder	48
Adaptor - Spacer Block Coil Spring Compressor	53
Adjustable Ball Joint Separators	57
Adjustable Body Blade Holder	76
Adjustable Hub Pullers	62, 151
Adjustable Tube Benders	46
Air Assisted Brake Caliper Windback Tool	50
Air Blow Gun	36, 95
Air Brake Bleeder	47
Air Holding Adaptor	18
Air Powered Hydraulic Pump	182
Aligning Tool - Clutch	23
Aluminium Air Powered Hydraulic Pump	182
Aluminium Hydraulic Pump	136, 182
Amp Meters	90
Angle Gauge - Torque Setting	101
Angled Spoon	73
Angled Surfacing Spoon	73
Antifreeze Hydrometers	29
Antifreeze Tester	29
Anvil Dolly	72
Auto Filler Unit	47
Auto Ranging Digital Multimeter	88-89
Automotive Circuit Testers	86-87
Automotive Digital Multimeter	88-89
Automotive Trim Removal Set	83
Axial Grip Welding Clamps	81
B	
Ball Joint Separators	57-58
Battery Acid Hydrometer	87
Battery Hydrometer	87
Battery Tester	87
Bearing Extractor Kit - Internal	148

Description	Page No.
Bearing Removal - Gearbox	23
Bearing Removal Kits - Blind Housing	150
Bearing Ring Puller Universal	63
Bearing Separator Puller Kits	124-130, 133, 148
Bearing Separators	149
Belt Tension Gauge	22
Bench Mount Sheet Metal Folder	78
Blind Housing Bearing Removal Kits	150
Blow Gun Air Tool	36, 95
Body Blade Holder	76
Body Blades	76
Body Panel Clamps	80-81
Body Repair Tool Kits	74-75
Body Repair Tools	70-76
Body Trim Remover	83
Brake Bleeding Tools	47-48
Brake Caliper Windback Kits	49-50
Brake Caliper Windback Tools	49-50
Brake Disc Run Out Set	50, 95
Brake Fluid Bleeders	47, 48
Brake Fluid Filler	47
Brake Fluid Tester	47
Brake Hose Clamp	51, 95
Brake Line Clamp	51, 95
Brake Pipe Corrosion Tool	46
Brake Pipe Flaring Tools	42, 43
Bumping Files	73
Bumping Spoons	73
Bumping Tools	73
C	
C Clamps	80
Caliper Piston Windback Tools	49-50
Calibration Tester - Torque Wrench	103
Car Seat Cover	84
Catalyst Back Pressure Tester	40
ChassisEars	65, 92
Circlip Pliers	23, 95
Circuit Testers	86-87
Clamps - Amp Meter	90
Clamps - Body Panel	80-81
Clamps - Welding	80-81
Clip Removers	83
Clutch Alignment Tool	23
Clutch Hose Clamp	51, 95
Coil Spring Compressor Jaw Sets	53

ALPHABETICAL INDEX

Description	Page No.
C cont.	
Coil Spring Compressors	52-54
Collet Extractor Adaptors	145-147
Combi Pull Slide Hammer Puller Kits	144-145
Combi-Puller System	112
Combustion Leak Testers	29
Commercial Vehicle Hub Pullers	62, 151
Common Rail Diesel Fuel Pressure Testers	34-35
Compact Welding Clamps	81
Compression Tester - Petrol	6-7
Compression Testers	6-12
Compression Testers - Diesel	7-12
Compressors - Coil Spring	52-54
Compressors - Piston Ring	17
Compressors - Ring	17
Compressors - Valve Spring	17, 19
Concentric Stud Extractor Set	94
Conical Hole Cutter	77
Container - Oil Can	96
Converter - Hydraulic Ram	118
Coolant Hydrometer	29
Cooling Pressure Testers	24-28
Cooling System - Combustion Tester	29
Cooling System - Hydrometer	29
Cooling System - Pressure Testers	24-28
Cooling System - Refractometer	29
Cooling System Pressure Tester - Car	24-27
Cooling System Pressure Tester - HGV	26-28
Copper Hammer	71
Copper Mallet	71
Cordless Circuit Testers	86
Corrosion Assessment Tool	84
Corrosion Tool - Brake Pipe	46
Coupling - Hydraulic	186
CRD - Fuel Pressure Testers	34-35
Current Clamp Amp Meter	90
Curved Bumping File	73
Curved Dolly	72
Curved Fine Cut Bumping File	73
Curved Head Dolly	72
Curved Jaw Grip Wrench	82, 96
Curved Medium Cut Bumping File	73
Curved Pein & Finishing Hammer	71
Curved Pein Hammer	71
Curved Thin Dolly	72

Description	Page No.
Cutter - Diesel Injector Seat	38
Cutter - Tube/Pipe	45
Cutting & Folding Tools - Sheet Metal	78
Cylinder - Hydraulic 20 Tonne	183
Cylinder - Hydraulic 30 Tonne	183
Cylinder - Hydraulic 50 Tonne	183
Cylinder Head Work Stands	20
Cylinder Hone Stones	16
Cylinder Hones	16
Cylinder Leakage Tester	13
CyroCobalt Drill Bits	77
D	
Dashboard Service Kit	83
Deburring Tools	45-46
Deep Throat C Clamps	80
Deep Throat Welding Clamps	80
Dial Gauge - Brake Disc	50, 95
Dial Gauge - Torque Angle	101
Dial Gauge - Tyre Pressure	66
Diesel Compression Tester	7-12
Diesel Cylinder Leakage Tester	13
Diesel Injector Puller	37-38
Diesel Injector Seal Extractors	38
Diesel Injector Seat Cutter	38
Diesel Injector Tester & Aspirator	39
Digital Amperage Clamps	90
Digital Angle Gauge	101
Digital Multimeter	88-89
Digital Tachometer	91
Digital Thermometer	91
Digital Torque Angle Gauge	101
Digital Tread Depth Gauge	66
Direct Action Ball Joint Separator	57
Disc Run Out Set	50, 95
Dollies - Panel Beating	72
Door Hinge Pin Remover	84
Door Skin Crimping Tools	79
Drill Bits	77
Drive Adaptor - Cailper Windback Tool	50
Drive Belt Stretcher	22, 96
Driver Set - Impact	51, 84, 96
Drop Arm Puller	58, 152
E	
Easy-Outs	93-94
Electrical Circuit Testers	86-90

ALPHABETICAL INDEX

Description	Page No.
Electrical Fault Finder	87
Electrical Multimeters	88-89
Electrical Testing - Amp Clamps	90
Electrical Testing - Circuit Testers	86-90
Electrical Testing - Fuse Block Connectors	87
Electrical Testing - Multimeters	87-90
Electronic Stethoscope	65, 92
Engine Compression Tester	6-12
Exhaust Flow Pressure Tester	40
Exhaust Pressure Tester	40
Expansion Plug Cooling System Tester	26
External Bearing Pullers	148
Extra Large C Clamp	80
Extractor Kit - Bearing Internal	148
Extractor Kits - Split Collet	145-147
Extractors - Screw/stud	93-94
F	
Fan Belt Stretcher	22, 96
Fast Fit Micro Puller	110
Feeler Gauges	20
Fibreglass Hole Cutter	77
Files - Body Repair	73, 76
Files - Panel Beating	73, 76
Files - Thread Restoring	93
Filter Removers - Oil	21
Fine Cut Body Blade	76
Finishing & Pick Hammer	71
Finishing Hammers	70-71
Fixed Plate Hub Pullers	59, 60, 152
Flanging & Crimping Tools	79
Flanging Tools	79
Flaremaster 2 Brake Pipe Tools	42
Flaring Tools - Deburrers	45-46
Flaring Tools - Flaremaster 2	42
Flaring Tools - Flaremaster 270 Series	43
Flat Blade Bumping Tool	73
Flat Bumping Tool	73
Flat Cut Body Blade	76
Flat Light Beating Hammer	70
Flexible Body Blade Holder	76
Flexible Drive Belt Stretcher	22, 96
Flexible Spout Oil Can	96
Fluted Screw/Stud Extractor & Drill Set	93
Ford Transit Front Hub & Wheel Bearing Kit	61
Fork Type Ball Joint Separator	58

Description	Page No.
Fuel Line Clamp	82, 96
Fuel Pressure Testers	30-35
Fuel Pressure Testers - Diesel	31, 33-35
Fuel Pressure Testers - Petrol	30-32
Fuse Block Connector Set	87
G	
Gauge - Belt Tension	22
Gauge - Compression	6-12
Gauge - Cooling System Pressure	24-28
Gauge - Cylinder Leakage	13
Gauge - Feeler	20
Gauge - Fuel Pressure	30-35
Gauge - Oil Pressure	15
Gauge - Tyre Pressure	66
Gauge - Tyre Tread Depth	66
Gauge - Vacuum	36
Gearbox Bearing Remover	23
General Purpose Spoon	73
Grid Dolly	72
Grid Toe Dolly	72
Grip Wrenches	82, 96
H	
Half Round Bumping Tool	73
Hammers - Panel Beating	70-71
Hand Edge Setter Flanging Tool	79
Hand Held Flanging Tool	79
Hand Held Hole Punch	77
Hand Held Panel Crimping Tool	79
Hatchet Dolly	72
Heavy Duty Torque Wrenches	100
Heavy Toe Dolly	72
Heel Dolly	72
High Capacity Two Speed Hydraulic Pump	182
High Pressure Pump Hose	186
Hinge Pin Remover	84
Hole Cutting Tools	77
Hole Punch	77
Hone Stones	16
Hones	16
Hook, Pick & Scraper Set	95
Hooks	95
Hose Pinch Off Clamp	82, 96
Hub & Front Wheel Bearing Kit	61
Hub & Knuckle Clamp Spreader	56, 63
Hub Clamp Spreader	56, 63

ALPHABETICAL INDEX

Description	Page No.
H cont.	
Hub Puller - Truck	64-65, 153-154
Hub Puller Slide Hammer	63
Hub Pullers	59-65, 151-154
Hydraulic Ball Joint Separator	58
Hydraulic Bearing Separator Puller Kit	124
Hydraulic Coupling	186
Hydraulic Cylinder - 20 Tonne Steel	183
Hydraulic Cylinder - 30 Tonne Aluminium	183
Hydraulic Cylinder - 50 Tonne Aluminium	183
Hydraulic Diesel Injector Puller	37
Hydraulic Gauge & Block Assembly	186
Hydraulic Hose Clamp	51, 95
Hydraulic Hub Puller Heavy Duty	60
Hydraulic Hub Pullers	59, 152
Hydraulic Jack Kit - 20 Tonne	184
Hydraulic Jack Kit - 30 Tonne	185
Hydraulic Jack Kit - 50 Tonne	185
Hydraulic Loadstar Pullers	134-143
Hydraulic Nut Splitter	94
Hydraulic Press Frame Kit	136, 138, 185
Hydraulic Pullers	118-143
Hydraulic Pullers - Loadstar	134, 143
Hydraulic Pump Accessories	186
Hydraulic Pumps	136, 182
Hydraulic Ram	118
Hydraulic Ram Converter	118
Hydraulic Ram Repair Kit	118
Hydraulic Thin Jaw Pullers	131-133
Hydraulic Toe Lift Jack Kit - 20 Tonne	184
Hydraulic Truck Wheel & Hub Puller	64-65, 153-154
Hydrometer - Battery	87
Hydrometer - Coolant	29
I	
Impact Driver Set	51, 84, 96
Impact Pitman/Drop Arm Puller	58, 152
Infra-Red Tachometer	91
Infra-Red Thermometer	91
Injector Puller - Hydraulic	37
Injector Puller - Slide Hammer	38
Injector Seal Extractors	38
Injector Seat Cutter	38
Injector Tester	39
Inspection Tools	91-92
Inteliprobe 6-24V	86

Description	Page No.
Internal Bearing Extractor	148
Internal Coil Spring Compressor	54
Internal Pulling Attachment	149
Internal Split Collet Pullers	146-147
Internal/External Slider Hammer Pullers	144-145
J	
Jack Kit - Hydraulic 20 Tonne	184
Jack Kit - Hydraulic 30 Tonne	185
Jack Kit - Hydraulic 50 Tonne	185
Jaw Covers - Spring Compressor	53
Jaw Sets - Spring Compressor	53
K	
Knuckle Clamp Spreader	56, 63
L	
Lambda Sensor Socket Set	40
Lappers - Valve	20
Large C Clamp	80
Laser Tachometer	91
Laser Thermometer	91
Leak Down Tester	13
Leak Tester - Combustion	29
Light Bumping Hammer	70
Light Shrinking Hammer	71
Loadstar Pullers	134-143
Lock Grip Pliers - Panel	80
Lock Grip Pliers - Welding	80
Locking Pliers	82, 96
M	
MacPherson Strut Clamp	55
MacPherson Strut Controller Kit	55
MacPherson Strut Lifter	56
Magnet	18, 96
Magnetic Pick-up Tool	18, 96
Mechanical Ball Joint Separators	57-58
Mechanical Hub Pullers	59-62, 151-152
Mechanical Pullers	108-117, 114-152
Merchandiser - Torque Wrenches	99
Metal Flanging Tools	79
Metal Hole Cutters	77
Micro Current Clamp Amp Meter	90
Micro Puller	110
Micro Welding Clamps	81
MIG Spot Welding Pliers	80
Mini Pullers	110
Mini Tube Cutters	45

ALPHABETICAL INDEX

Description	Page No.
Mobile Truck Wheel Trolley	64-65
Motorq Torque Angle Gauges	101
Motorq Torque Wrenches	98-100
Multicut Hole Cutters	77
Multimeters	88-89
Multipull Blind Housing Bearing Pullers	150
N	
Nut Splitters	94
O	
Oil Can	96
Oil Filter Removers	21
Oil Pressure Gauge	15
Oil Pressure Tester	15
Omnium Grip Wrench	82, 96
Oval Adaptor - Pressure Brake Bleeder	48
Oxygen (Lambda) Sensor Socket Set	40
P	
Panel Beating Body Repair Kits	74-75
Panel Beating Bumping Files	73
Panel Beating Bumping Spoons	73
Panel Beating Clamps	80-81
Panel Beating Dollies	72
Panel Beating Drills	77
Panel Beating Edge Setters	79
Panel Beating Files	73
Panel Beating Hammers	70-71
Panel Beating Panel Puller	76
Panel Beating Sheet Metal Tools	78
Panel Beating Shrinking Hammer	71
Panel Beating Slide Hammer	76
Panel Beating Spoons	73
Panel Beating Tool Kits	74-75
Panel Beating Welding Clamps	80-81
Panel Bonding Tools	79
Panel Crimping Tools	79
Panel Hole Punch	77
Panel Puller	76
Pencil Tyre Pressure Gauge	66
Petrol - Fuel Pressure Testers	30-33
Petrol Compression Tester	6
Petrol Cylinder Leakage Tester	13
Pick & Finishing Hammer	71
Pick Hammer	71
Picks	95
Pick-up Magnet	18, 96

Description	Page No.
Pinch Wedge Dolly	72
Pipe Aid Pliers	45
Pipe Benders	46
Pipe Cutters	45
Pipe Deburring Tools	45-46
Pipe Flaring Tools	42-44
Piston Ring Compressors	17
Piston Windback Tool - Air Assisted	50
Piston Windback Tools - Brake	49-50
Pitman Arm Puller	58, 152
Plastic Cut Body Blade	76
Plastic Hole Cutter	77
Pliers - Circlip	23, 95
Pliers - Panel Beating	80
Pliers - Pipe Aid	45
Pliers - Valve Stem Seal	18
Pliers - Welding	80
Polarity Tester	86
Portable Hydraulic Pump	136, 182
Press Frame Kit - Hydraulic	136, 138, 185
Pressure Brake Bleeders	48
Pressure Gauge - Oil	15
Pressure Tester - Cooling System	24-28
Pressure Tester - Fuel System	30-35
Pressure Tester - Oil	15
Professional Torque Wrenches	98-100
Protective Car Seat Cover	84
Pry & Surfacing Spoon	73
Pry Spoon	73
Pullers - Blind Housing Bearing	150
Pullers - Display Board Kits	155-161
Pullers - External Bearing	148
Pullers - Gearbox	23
Pullers - Hub	59-65, 151-154
Pullers - Hydraulic	118-143
Pullers - Hydraulic Loadstar	134-143
Pullers - Hydraulic Thin Jaw	131-133
Pullers - Hydraulic Truck Wheel & Hub	64-65, 153-154
Pullers - Mechanical	108-117, 114-152
Pullers - Mechanical Thin Jaw	115-117
Pullers - Merchandisers	155-161
Pullers - Micro Puller	110
Pullers - Mini Bearing	110
Pullers - Pitman/Drop Arm	58, 152
Pullers - Shadow Board Kits	155-161

ALPHABETICAL INDEX

Description	Page No.
P cont.	
Pullers - Slide Hammer	144-147
Pullers - Split Collet Extractors	145-147
Pulley Holding Tool	22
Pumps - Couplers	186
Pumps - Gauge & Block	186
Pumps - Hose	186
Pumps - Hydraulic	136, 182
R	
Radio Removal Kit	83
Ram - Hydraulic	118
Ratchet Sheet Metal Cutters	78
Ratchet Torque Wrenches	98-100
Rawhide Hammer	71
Rawhide Mallet	71
Refractometer	29
Remote Diesel Injector Test Actuator	39
Removers - Oil Filter	21
Repair Kit - Hydraulic Ram	118
Ring Compressors - Piston	17
Rolastep Flanging Tools	79
Round Dolly	72
Round Head Dolly	72
Rubber Hammer	71
Rubber Mallet	71
Rust Assessment Tool	84
S	
Safety Cage	53
Scrapers	95
Screw Extractors	93
Screw Impact Driver Set	51, 84, 96
Screwdrivers - Torque Screwdrivers	104
Seal Extractors - Diesel Injector	38
Seat Cover	84
Seat Cutter - Diesel Injector	38
Seat Protector	84
Sensor Socket Set - Oxygen (Lambda)	40
Separator & Puller Kits - Hydraulic	124-130
Separator & Puller Kits - Hydraulic Thin Jaw	133
Separator & Puller Kits - Mechanical	113-114
Separator & Puller Kits - Mechanical Thin Jaw	117
Separator Add On Pack - Loadstar 20 Tonne	136-137
Separator Add On Pack - Loadstar 30 Tonne	136, 140
Separator Add On Pack - Loadstar 50 Tonne	136, 142
Separators - Ball Joint	57-58

Description	Page No.
Separators - Bearing	149
Separators - External Bearing Pullers	148
Separators - Fork Type	58
Sheet Metal Clamp	80
Sheet Metal Cutters	78
Sheet Metal Folder	78
Sheet Metal Tools	78
Shrinking Hammer	71
Slide Hammer - Internal/External Puller	144-145
Slide Hammer Assembly 4.5kg	63, 153
Slide Hammer Diesel Injector Puller	38
Slide Hammer Hub Pullers	59, 60, 152
Slide Hammer Split Collet Extractor Kits	146-147
Slimline Brake Caliper Adaptor Set	50
Sonoscope	92
Sound Detector	92
Spiral Screw/Stud Extractor Sets	93
Split Collet Extractor Adaptors	145-147
Split Collet Extractor Kits	145-147
Split Jaw Locking Clamp	80
Spoons - Panel Beating	73
Spot Weld Drill Bits	77
Spot Weld Pliers	80
Spot Weld Removers	77
Spreader - Hub & Knuckle Clamp	56, 63
Spring Compressor - Accessories	53
Spring Compressor - Coil Spring	52-54
Spring Compressor - Safety Cage	53
Sprocket Holding Tool	22
Standard Bumping Hammer	70
Standard Cut Body Blade	76
Stands - Cylinder Head Working	20
Steel Wire Brush	93
Steering Ball Joint Separators	57-58
Stethoscope	92
Stethoscope - Electronic	65, 92
Storage Case - Torque Wrench	100
Straight Pein Finishing Hammer	70
Straight Pein Hammer	70
Strap - Oil Filter	21
Stretch Drive Belt Installers	22, 96
Strut Clamp Universal	55
Strut Controller Kit	55
Strut Lifter Support Tool	56
Strut Support Tool	56

ALPHABETICAL INDEX

Description	Page No.
S cont.	
Stud Extractors	93-94
Stud Setters	94
Surfacing & Pry Spoon	73
T	
Tachometer	91
Telescopic Magnet	18, 96
Tension Gauge - Belt	22
Tester - Brake Fluid	47
Tester - Catalyst Pressure	40
Tester - Cooling Pressure	24-28
Tester - Diesel Injector	39
Tester - Exhaust Pressure	40
Tester - Fuel Pressure	30-35
Thermometer	91
Thin Curved Dolly	72
Thin Dolly	72
Thin Jaw Axial Grip Welding Clamp	81
Thin Jaw Pullers - Hydraulic	131-133
Thin Jaw Pullers - Mechanical	115-117
Thin Toe Dolly	72
Thread Files	93
Thread Protectors	149
Thread Restoring Files	93
Timing Belt Tension Gauge	22
Toe Dolly	72
Torque Angle Gauges	101
Torque Kit - Tyre Pressure Monitoring	66, 104
Torque Multipliers	102
Torque Screwdrivers	104
Torque Wrench Calibration - TruCheck	103
Torque Wrench Merchandiser	99
Torque Wrench Storage Case	100
Torque Wrenches	98-100
Tread Depth Gauges	66
Trim & Clip Removers	83
Trim Clip Remover Pliers	83
Trolley - Truck Wheel Puller	64-65
TruCheck Plus 1000	103
TruCheck Plus 350	103
Truck Wheel & Hub Puller	64-65, 153-154
Truck Wheel Trolley	64-65
Tube Bending Tools	46
Tube Cutters	45
Tube Deburring Tools	45-46

Description	Page No.
Twin Beam Pulling Unit	147
Two Speed Hydraulic Pump	182
Tyre Pressure Gauge - Dial	66
Tyre Pressure Gauge - Pencil	66
Tyre Pressure Monitoring System Torque Kit	66, 104
Tyre Tread Depth Gauges	66
U	
Universal Bearing Ring Puller	63
Universal Body Trim Tools	83
Universal Brake Cailper Windback Tool	49
Universal MacPherson Strut Clamp	55
Universal Sprocket Holding Wrench	22
Utility Dolly	72
V	
Vacuum Brake Bleeder	47
Vacuum Gauge Kit	36
Vacuum Systems Tester	36
Valve Grinders	20
Valve Holding Tool	18
Valve Lappers	20
Valve Repair Tools	17-20
Valve Spring Compressors	17, 19
Valve Stem Seal Installer	18
Valve Stem Seal Pliers	18
Valve Tools	17-20
Vice Mounted Coil Spring Compressor	52-53
Vice Mounted Sheet Metal Folder	78
W	
Wedge Dolly	72
Welding Clamps	80-81
Wheel Puller - Truck	64-65, 153-154
Wire Brush	93
Wireless Electronic Stethoscope - ChassisEar	65, 92
Wrench - Pulley Holding	22
Wrench - Sprocket Holding	22
Wrench - Torque Wrenches	98-100
Z	
Zipcut Spot Weld Removers	77



Sykes-Pickavant Export Limited

Unit 9

Pillaton Hall Farm

Penkridge

Staffordshire ST19 5RZ

United Kingdom

T: +44 (0) 1785 714 320

F: +44 (0) 1785 714 281

Email: sales@spexport.co.uk

www.spexport.co.uk